




m29000

**TTL
PROCESSOR
FAMILY**



 **MOTOROLA Semiconductor Products Inc.**

M2900 TTL PROCESSOR FAMILY

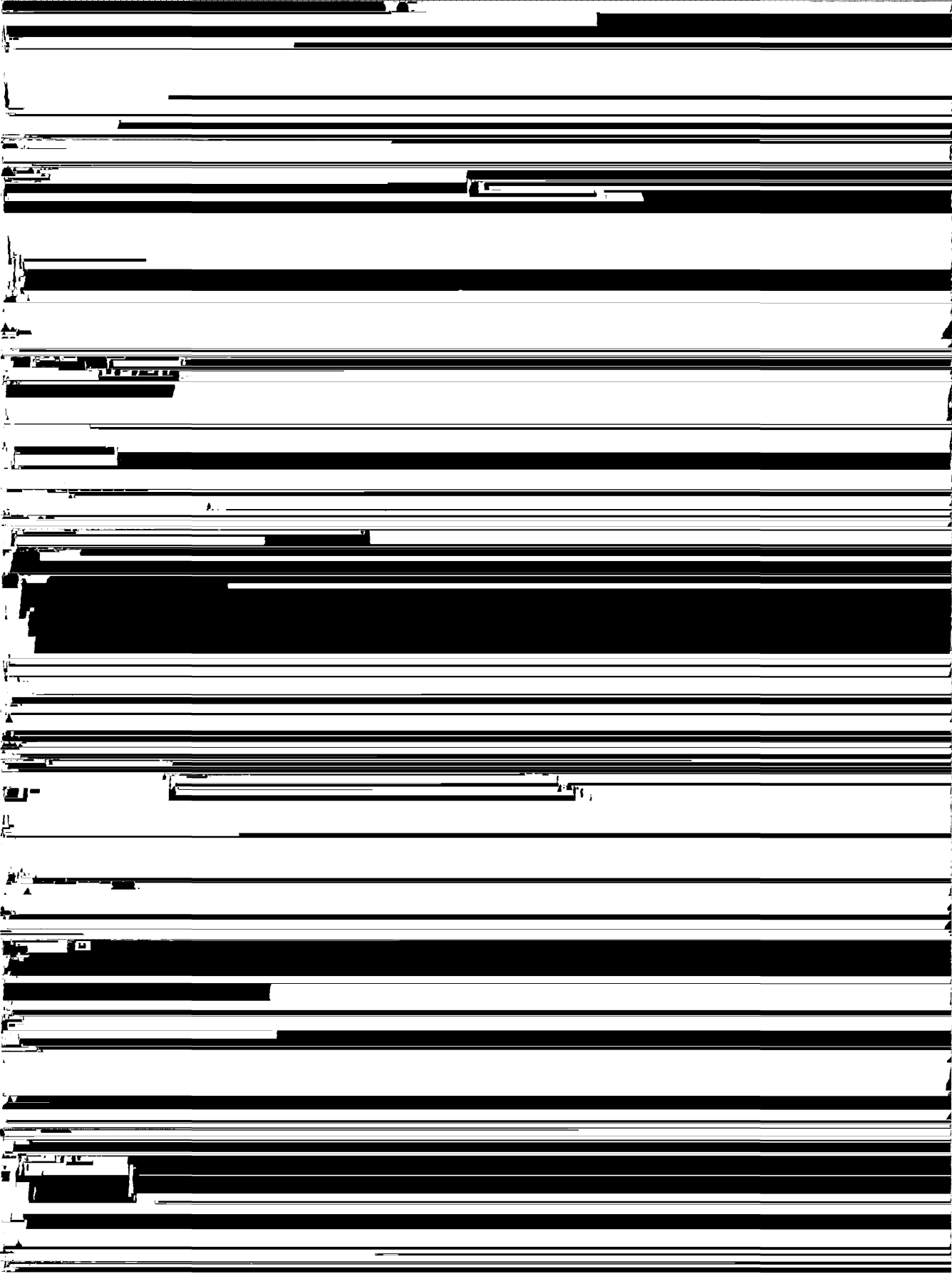
Circuit diagrams external to Motorola products are included as a means of illustrating typical semiconductor applications; consequently, complete information sufficient for construction purposes is not necessarily given. The information in this brochure has been carefully checked and is believed to be entirely reliable. However, no responsibility is assumed for inaccuracies. Furthermore, such information does not convey to the purchaser of the semiconductor devices described any license under the patent rights of Motorola Inc. or others.

Motorola reserves the right to change specifications without notice.

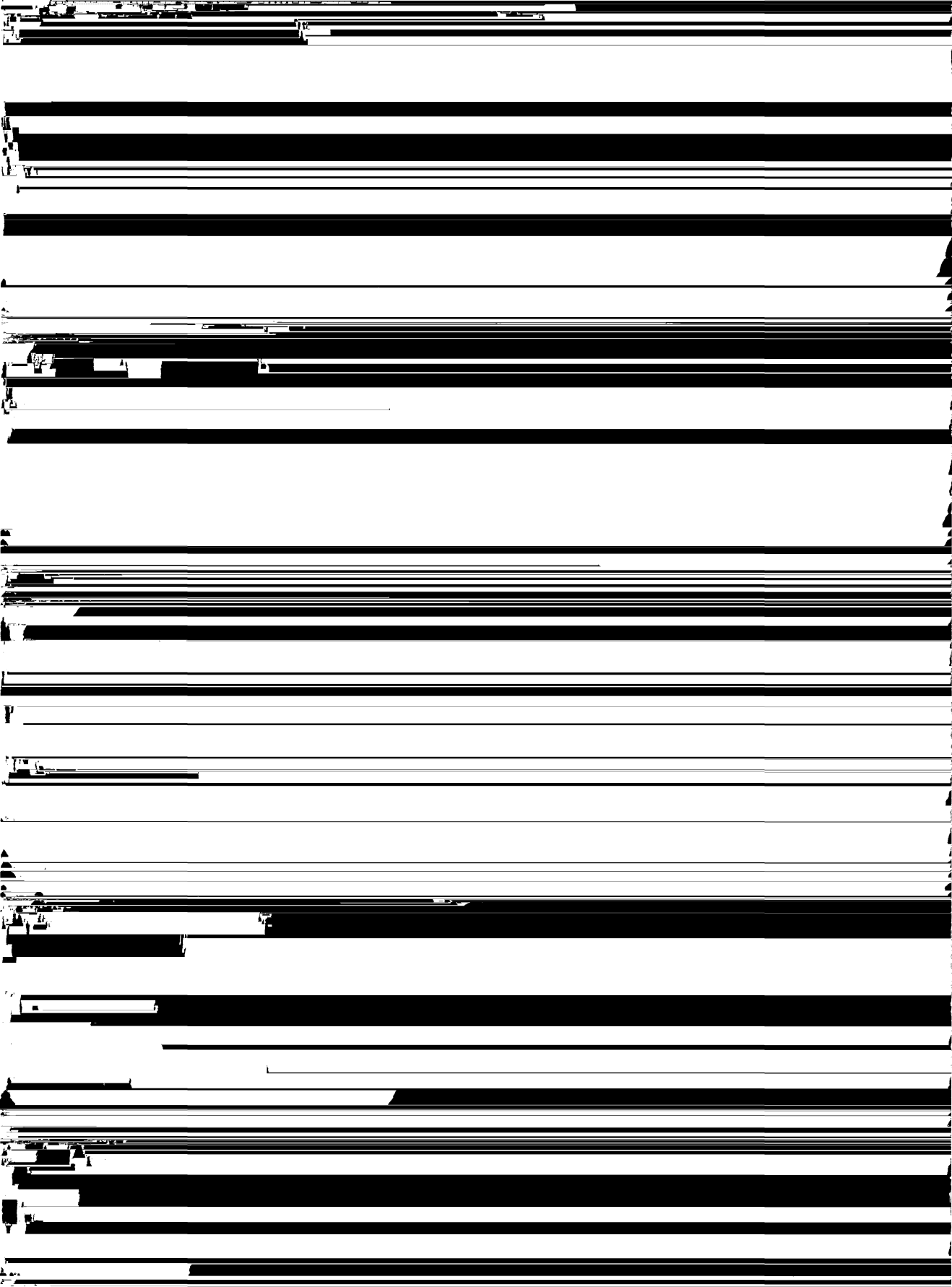
MTTL & MDTL are trademarks of Motorola Inc.

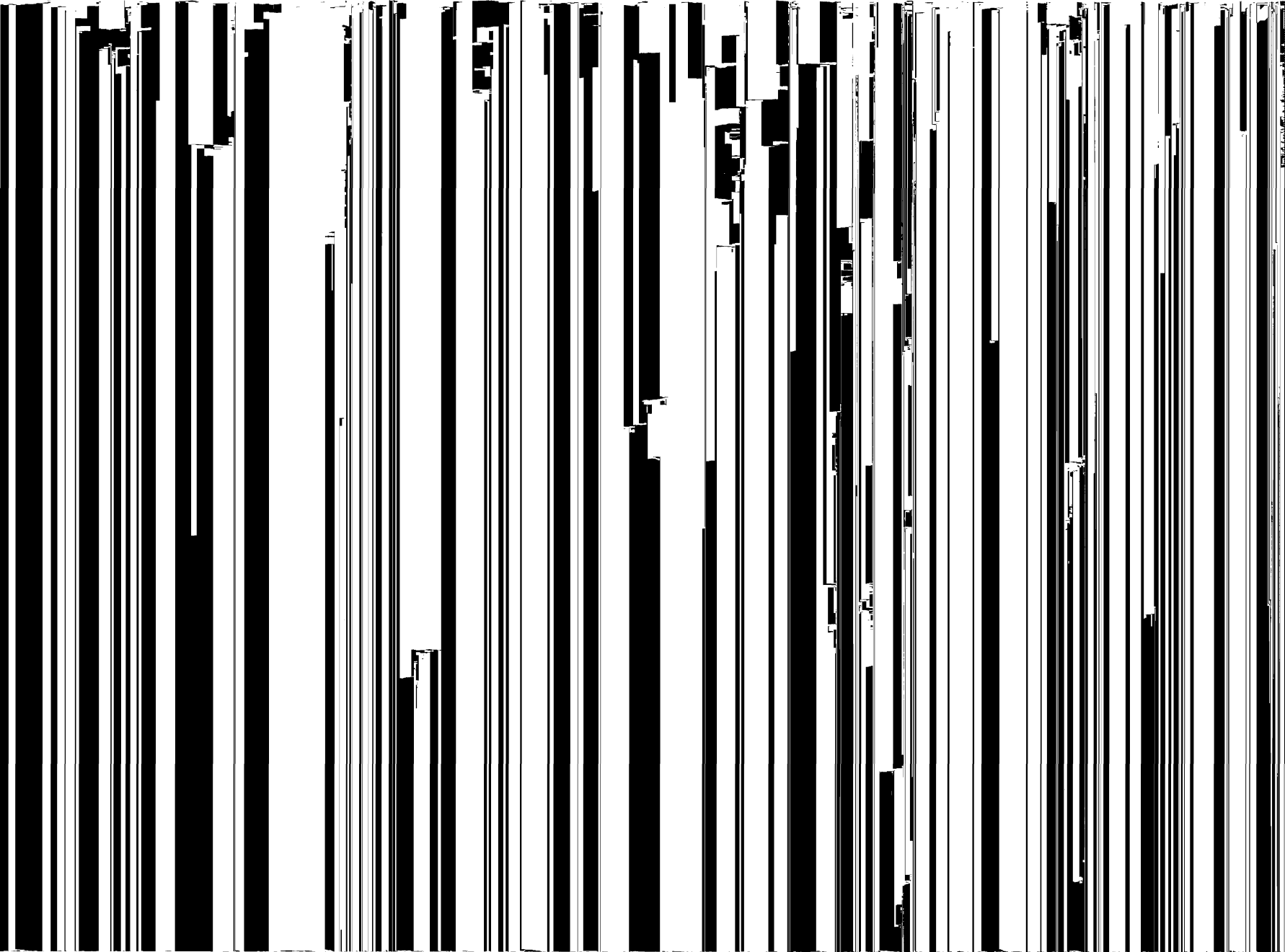
Second Edition
©MOTOROLA INC., 1977
Previous Edition ©1976
"All Rights Reserved"

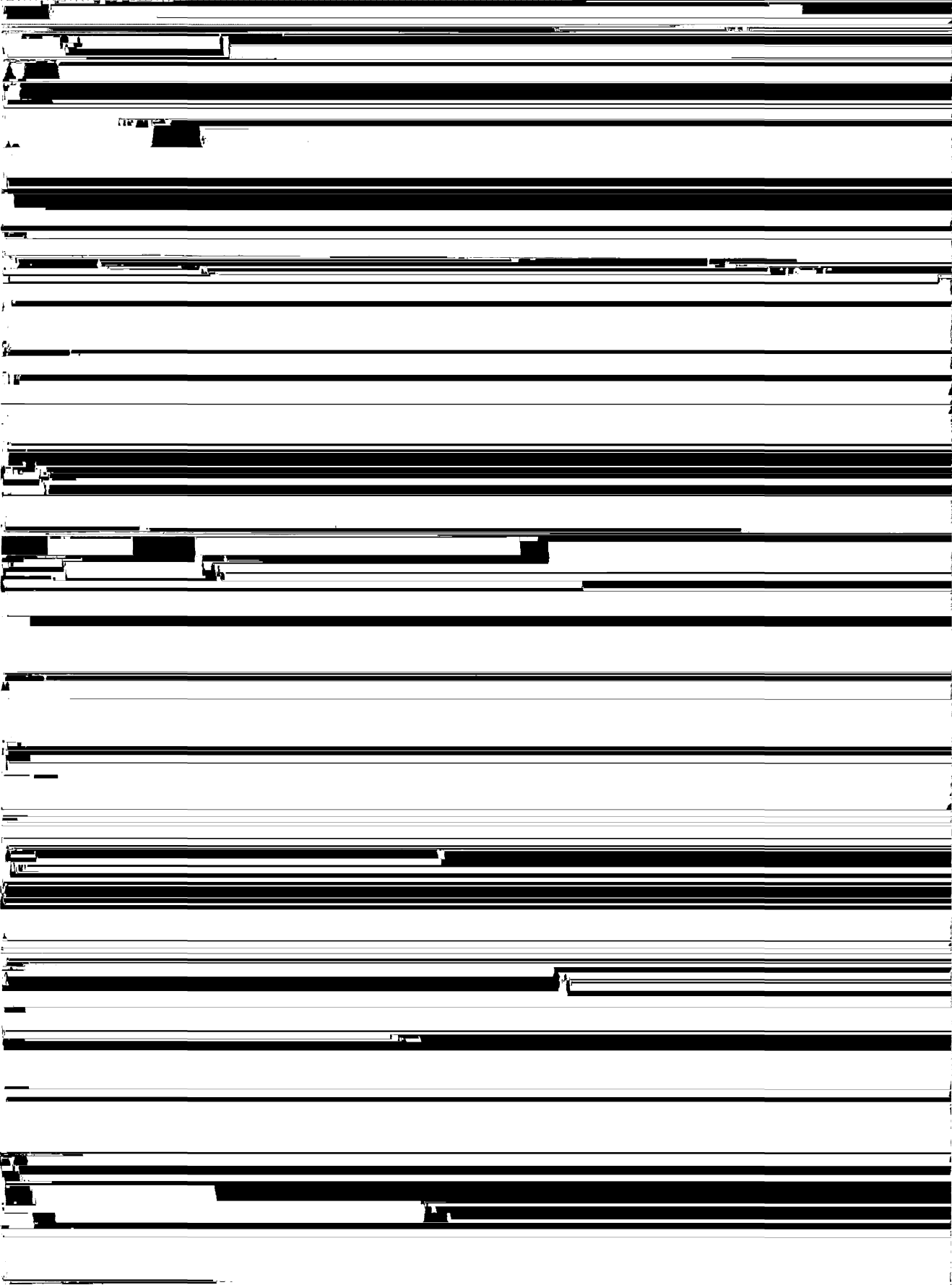
Printed in U.S.A.



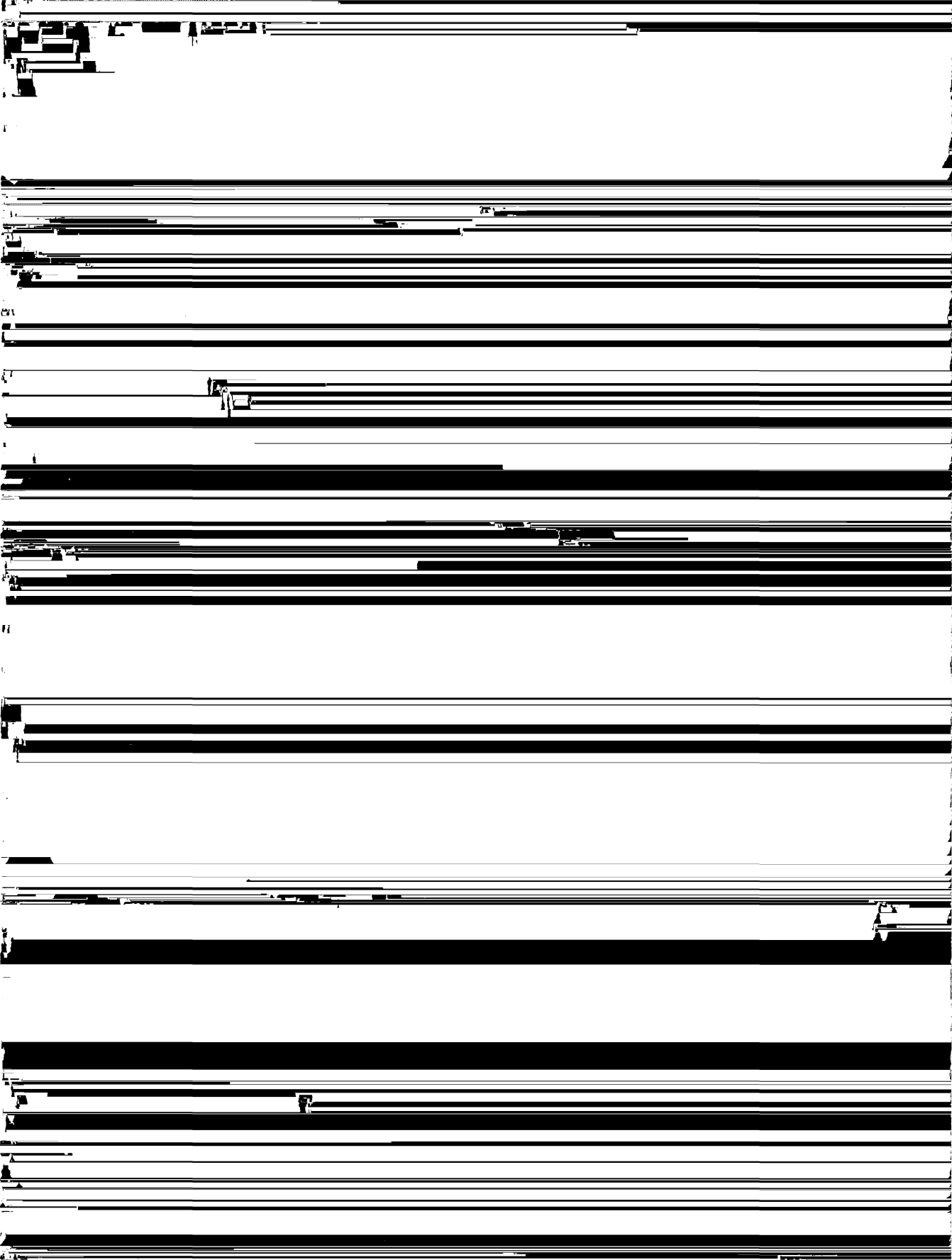


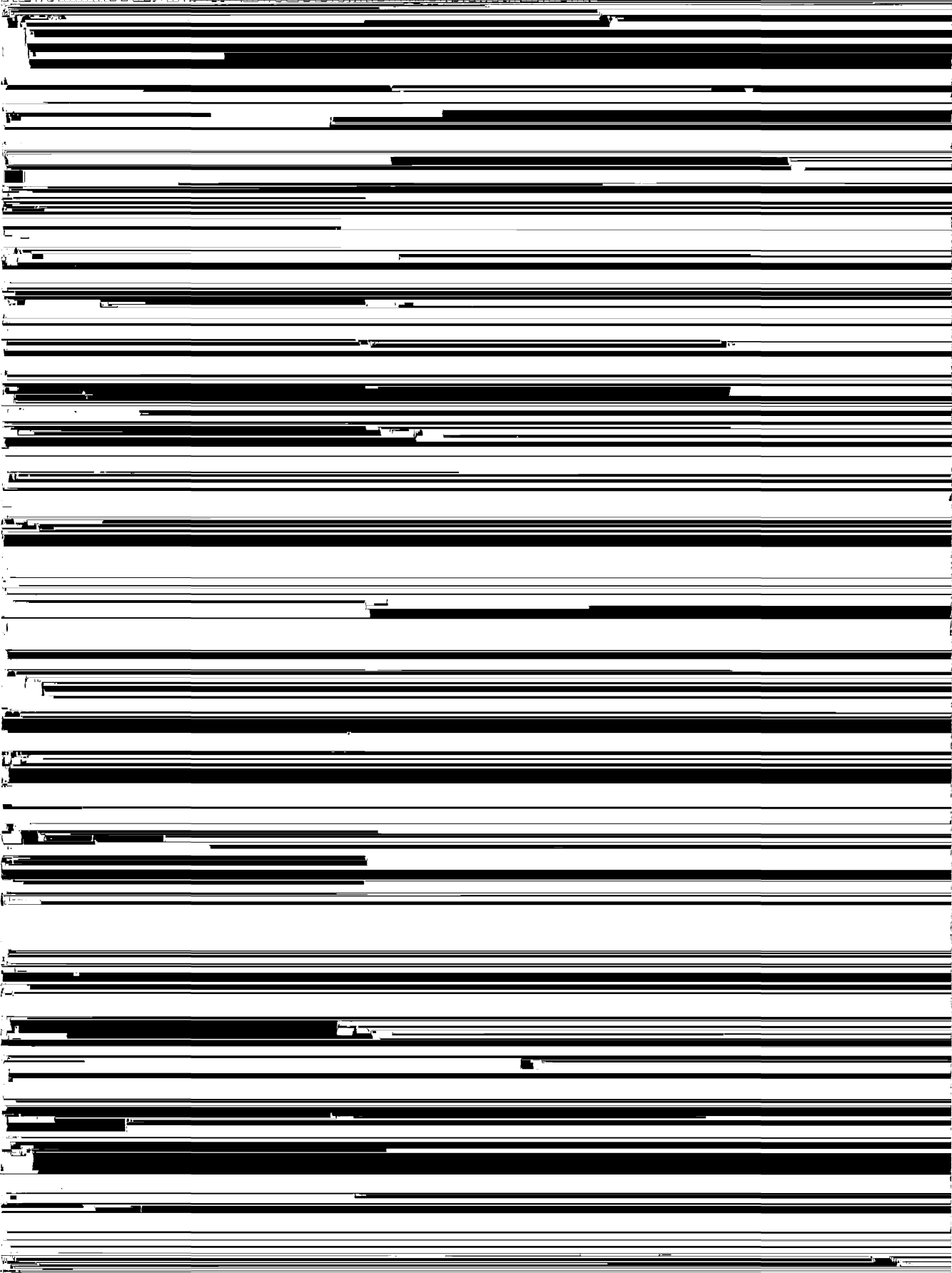


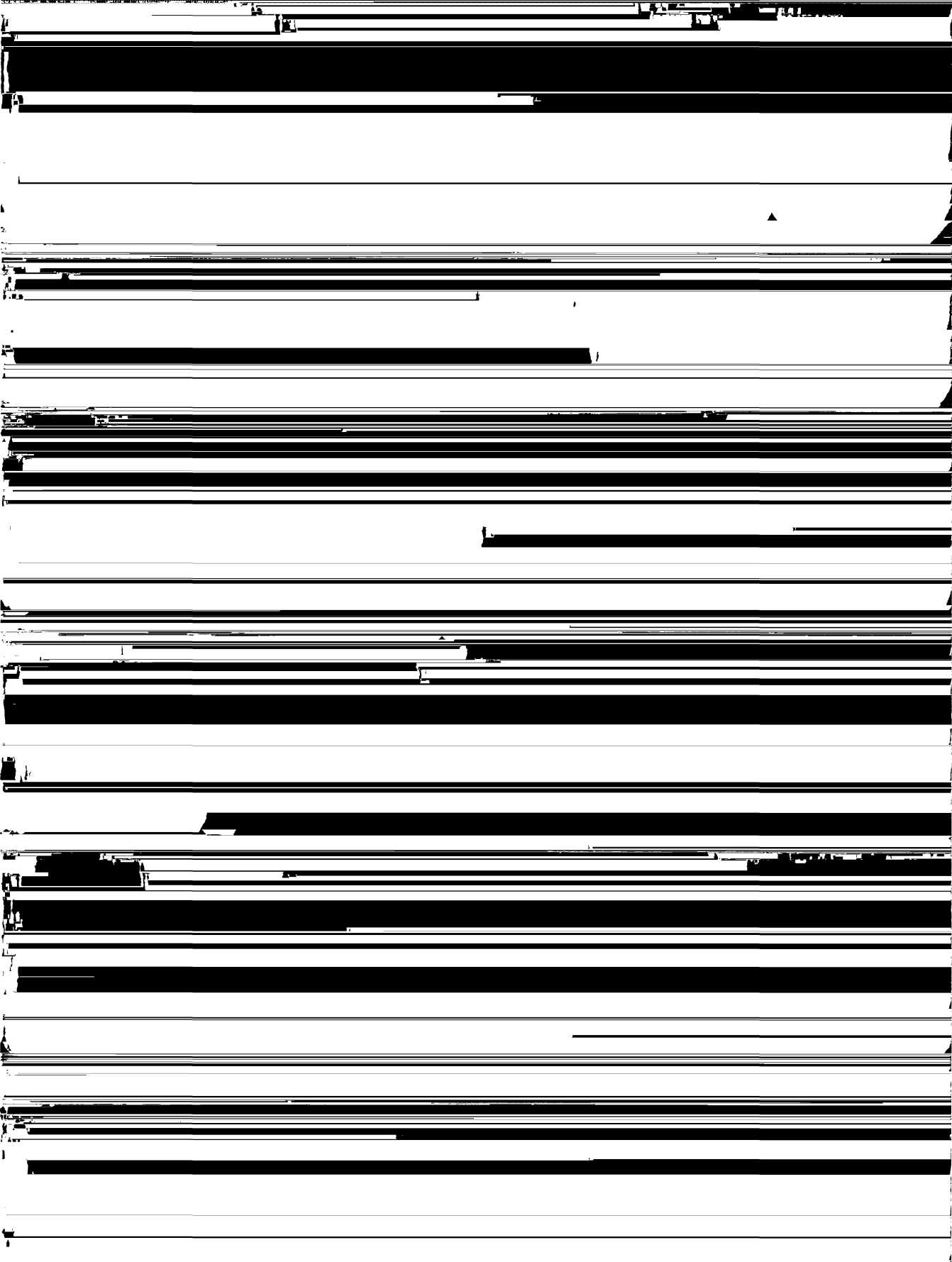


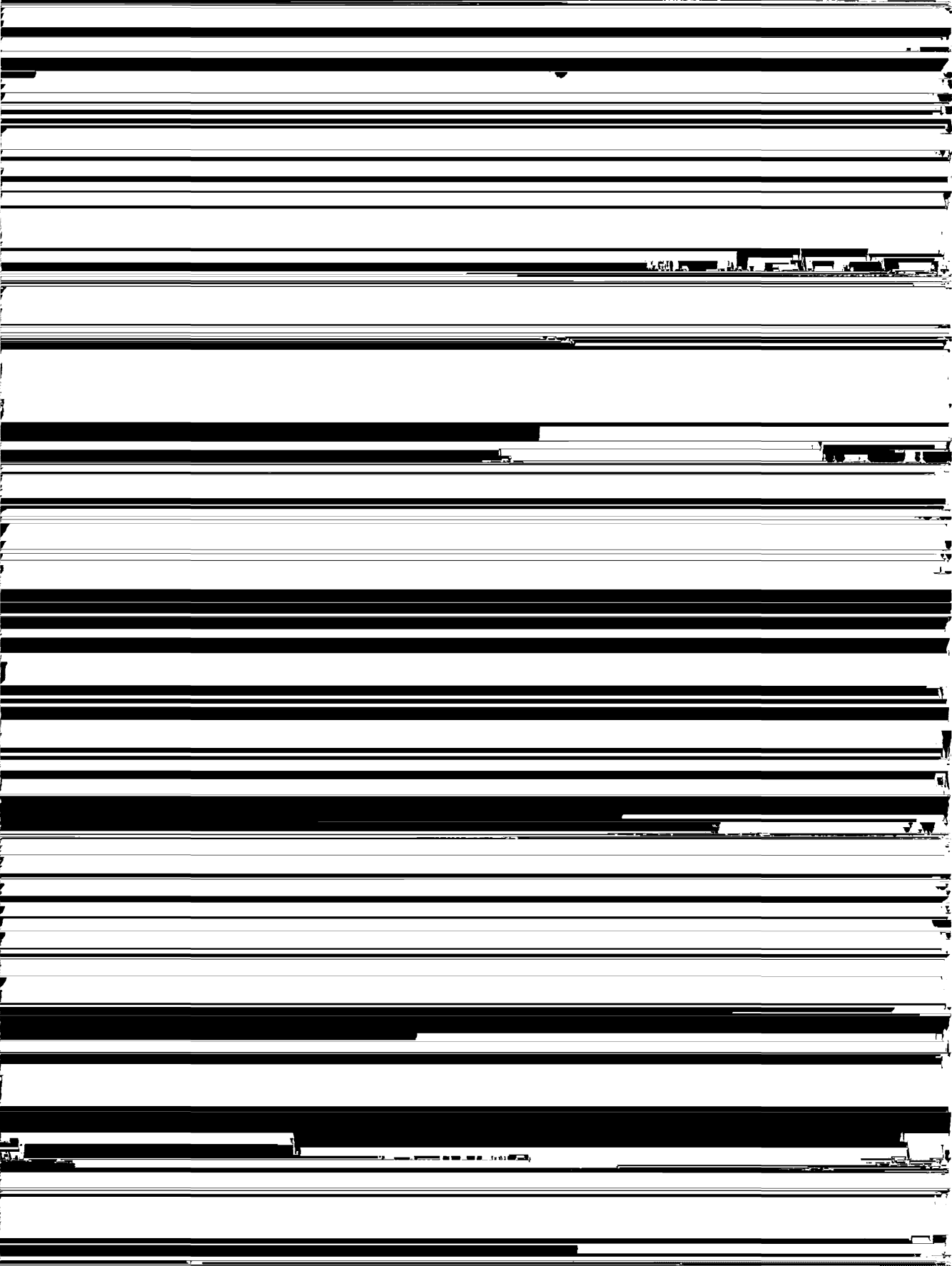


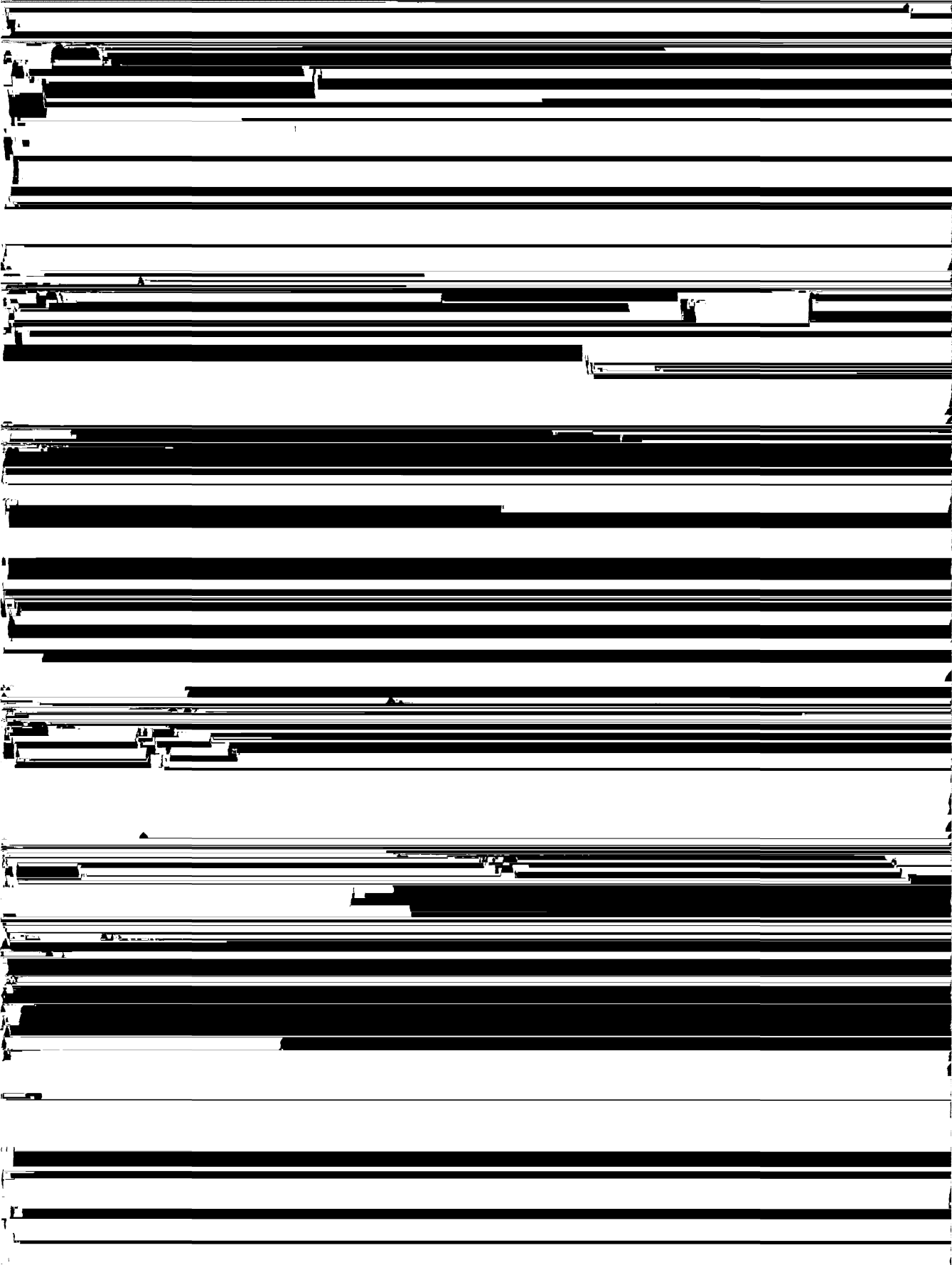


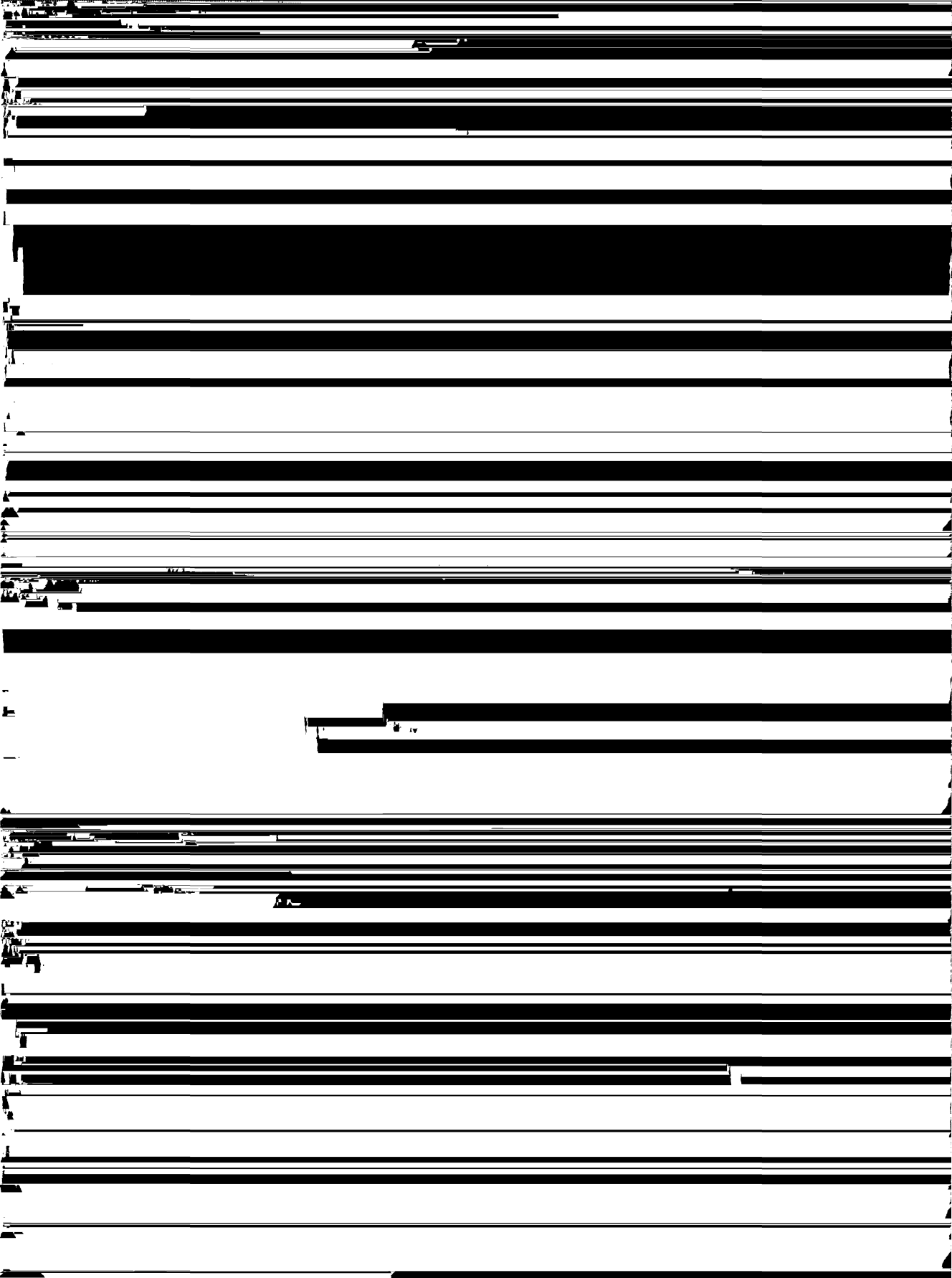


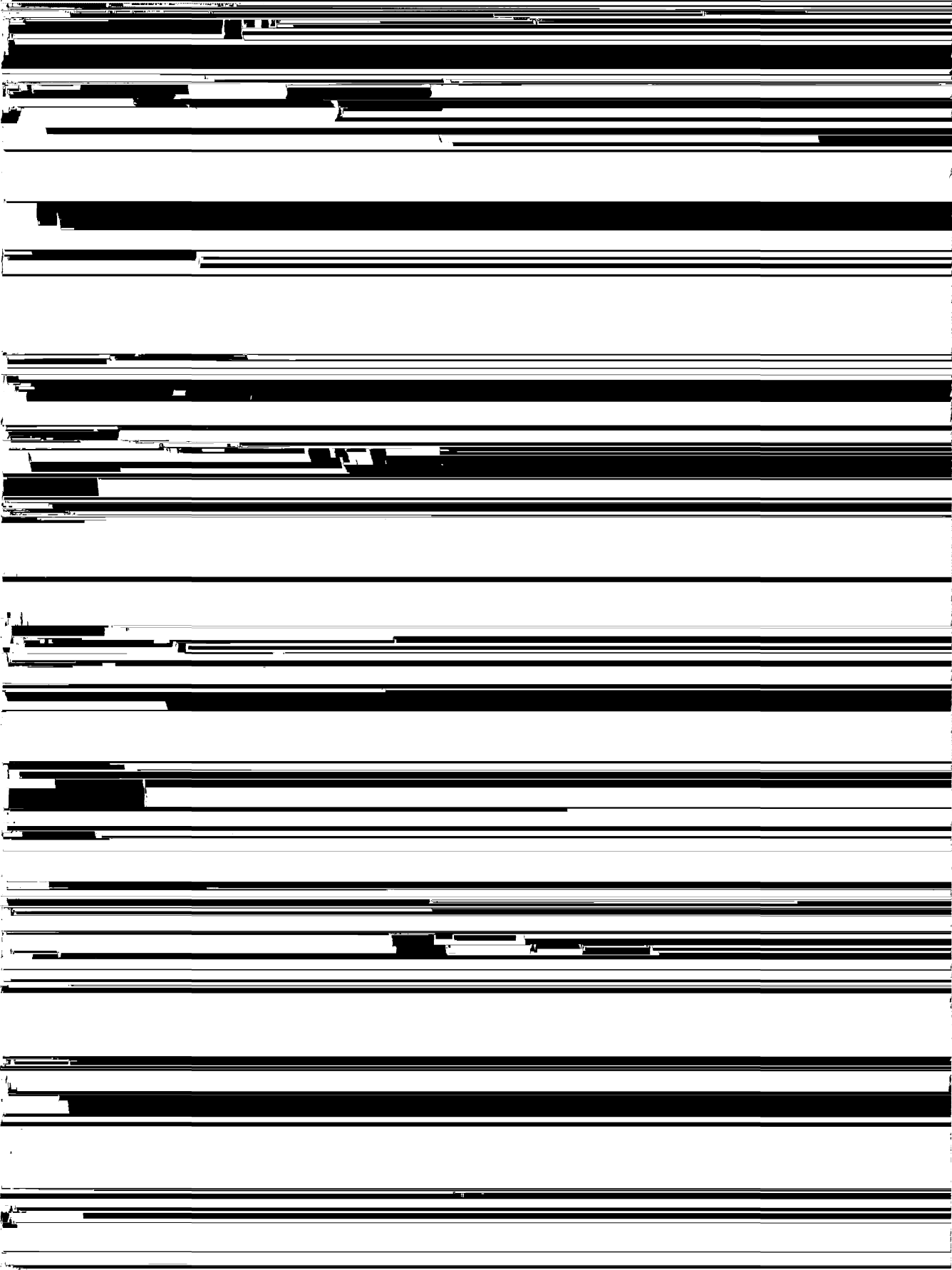


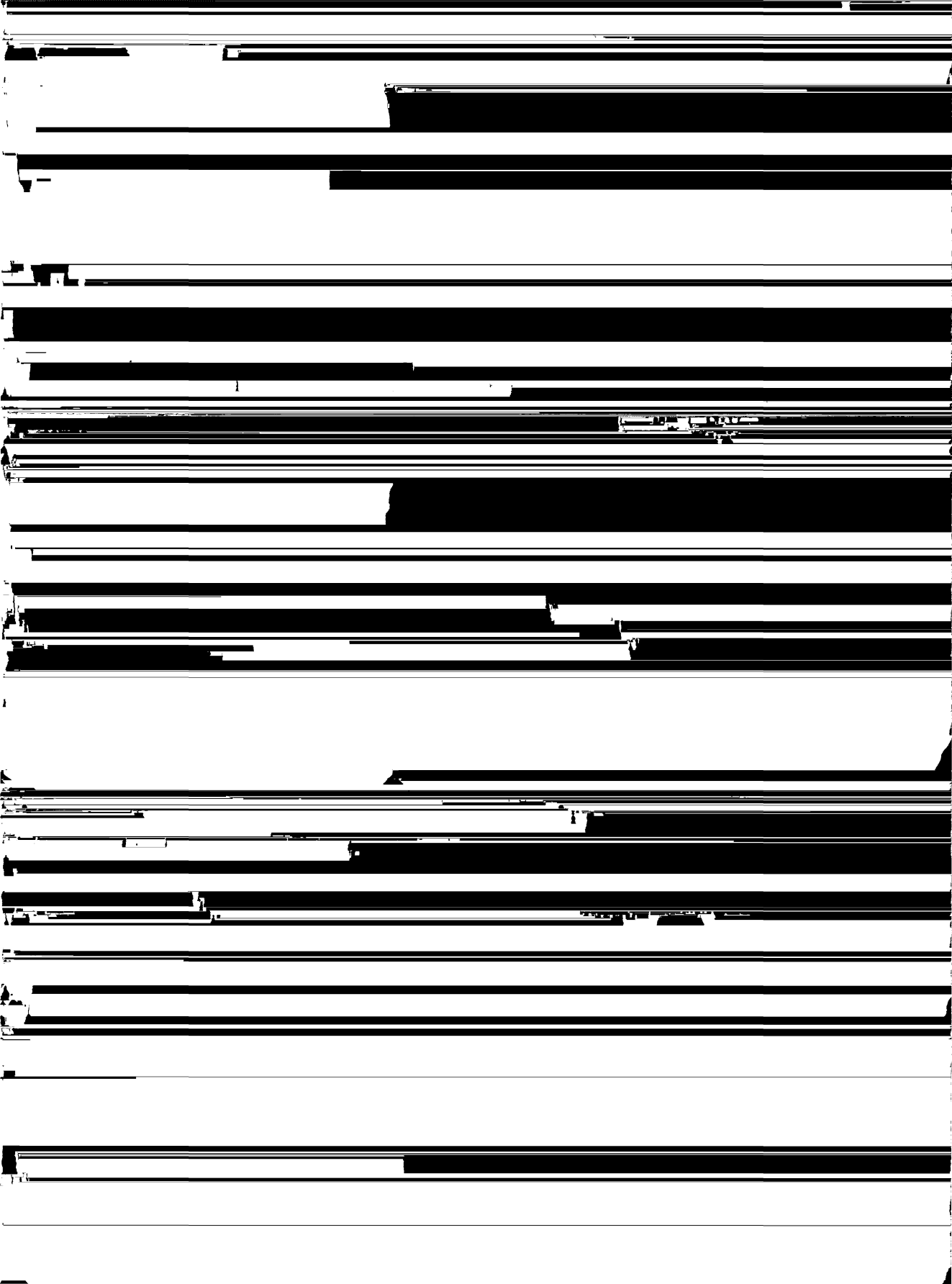


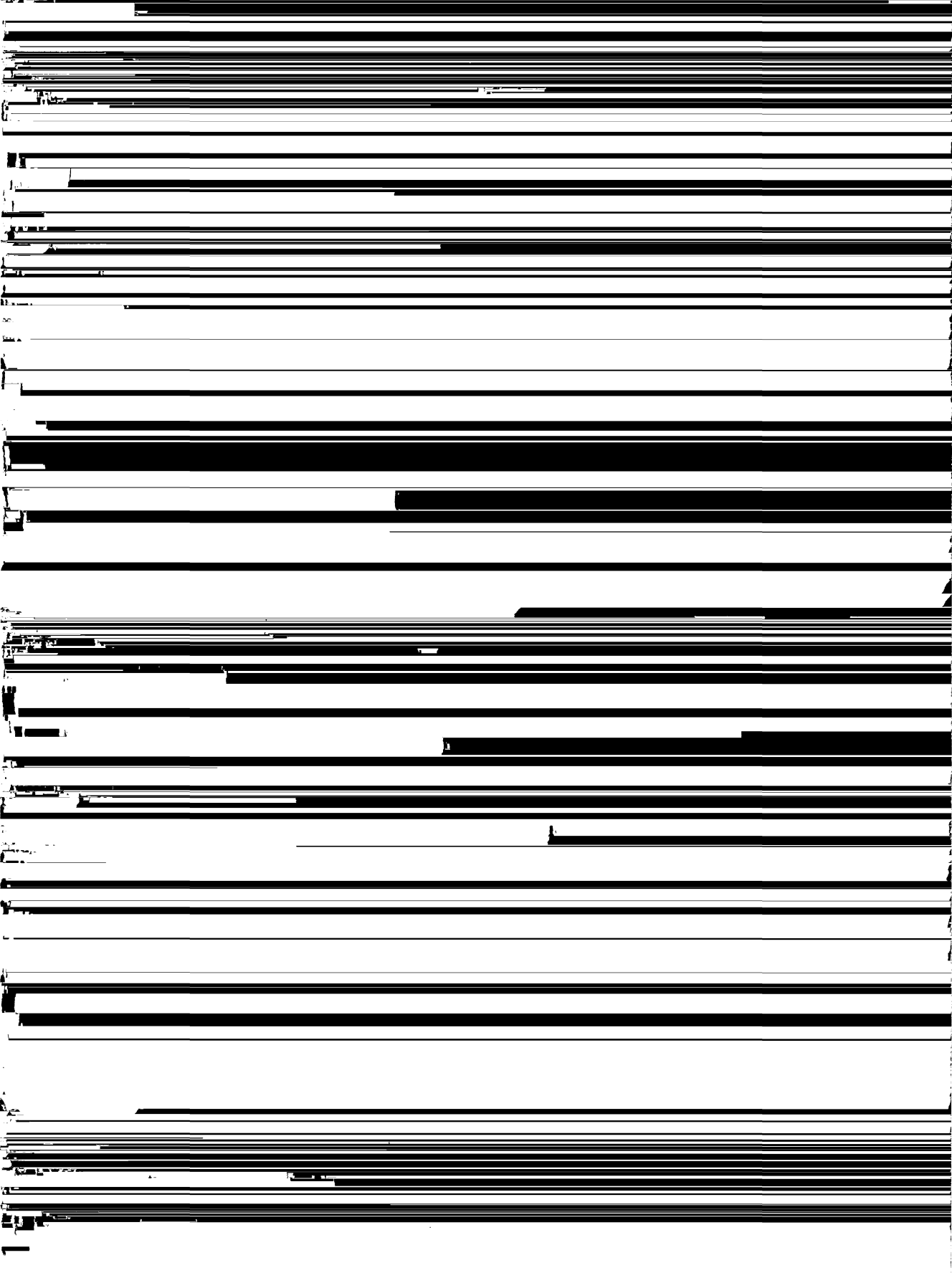


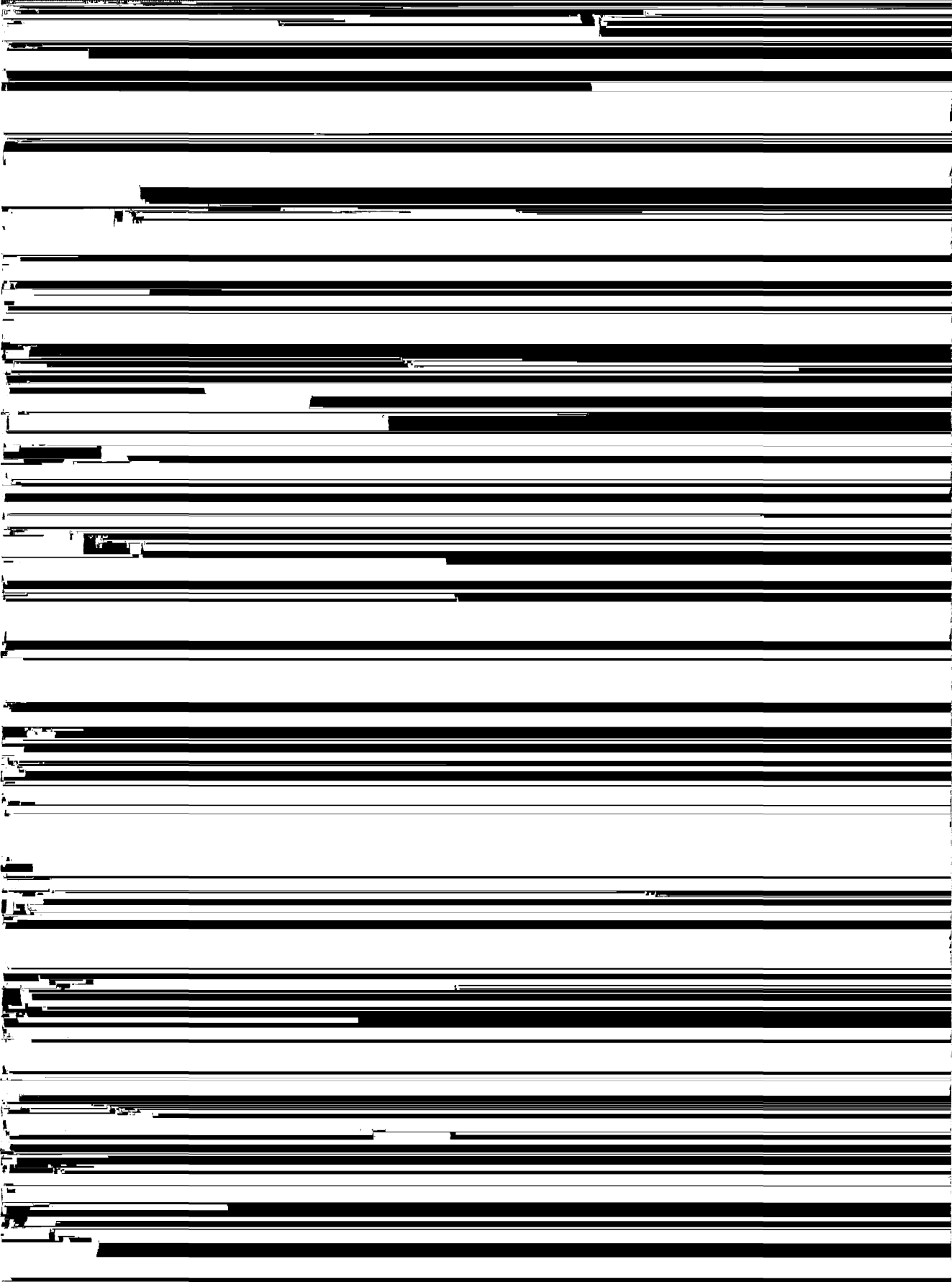


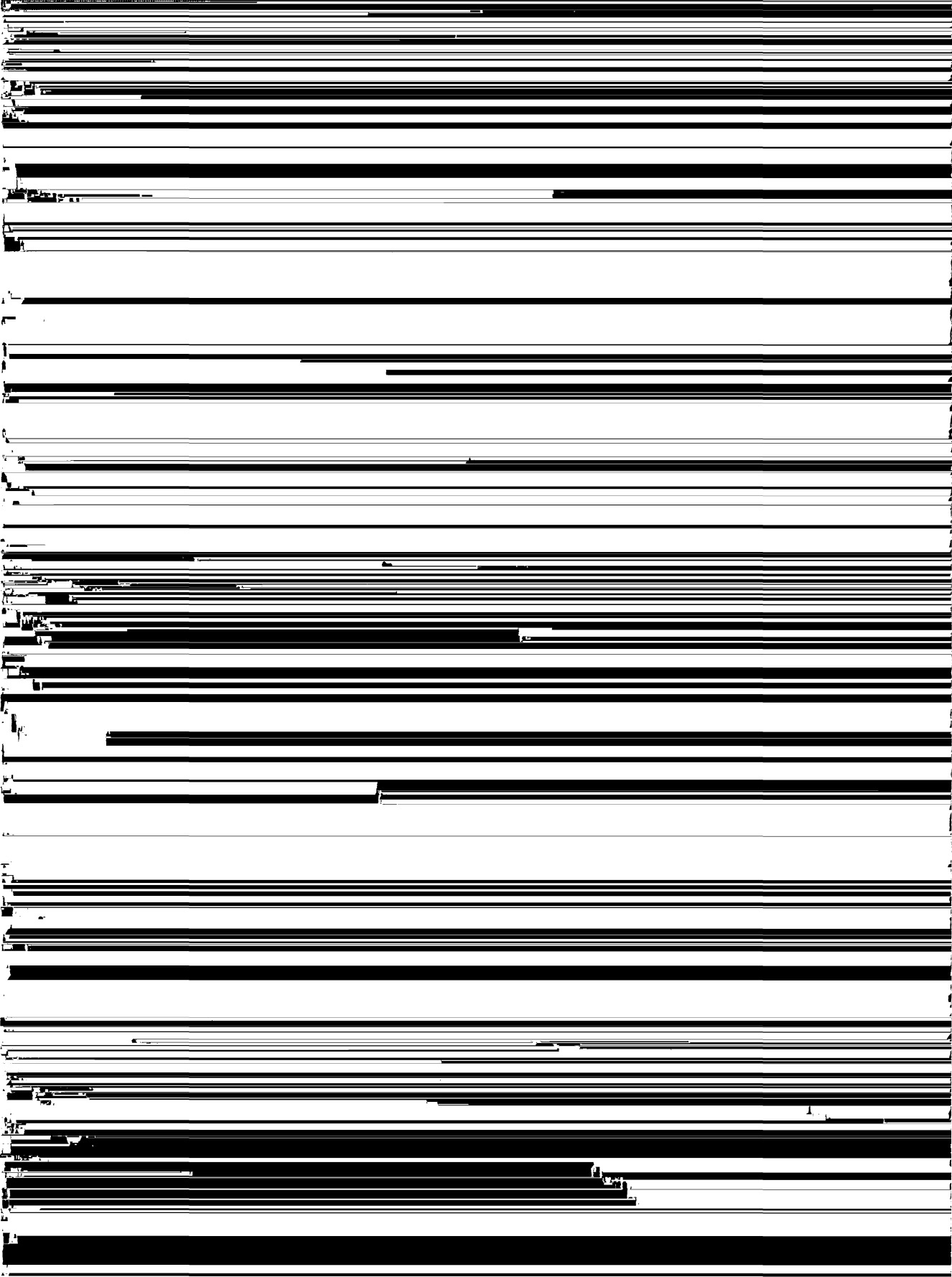


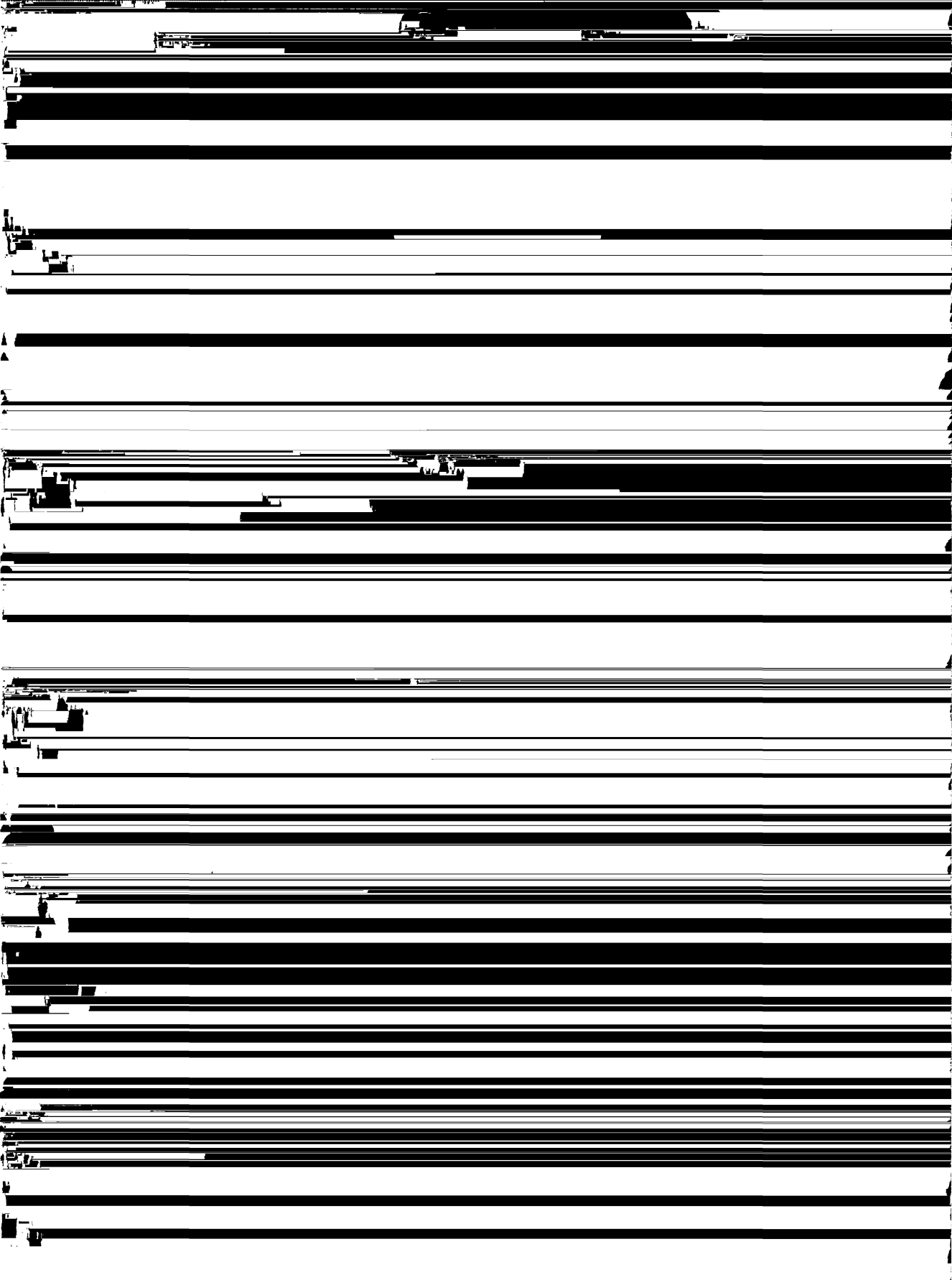






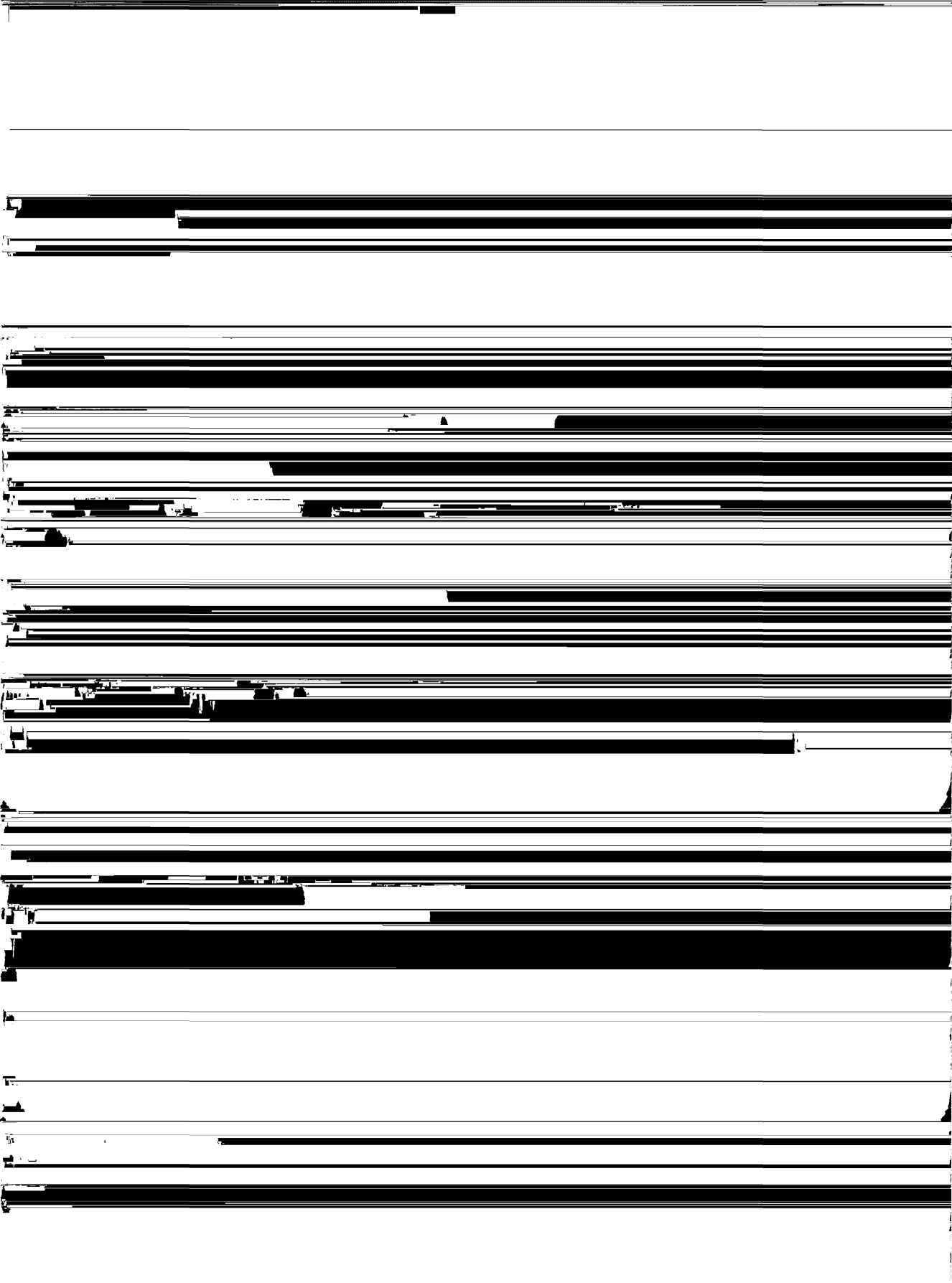


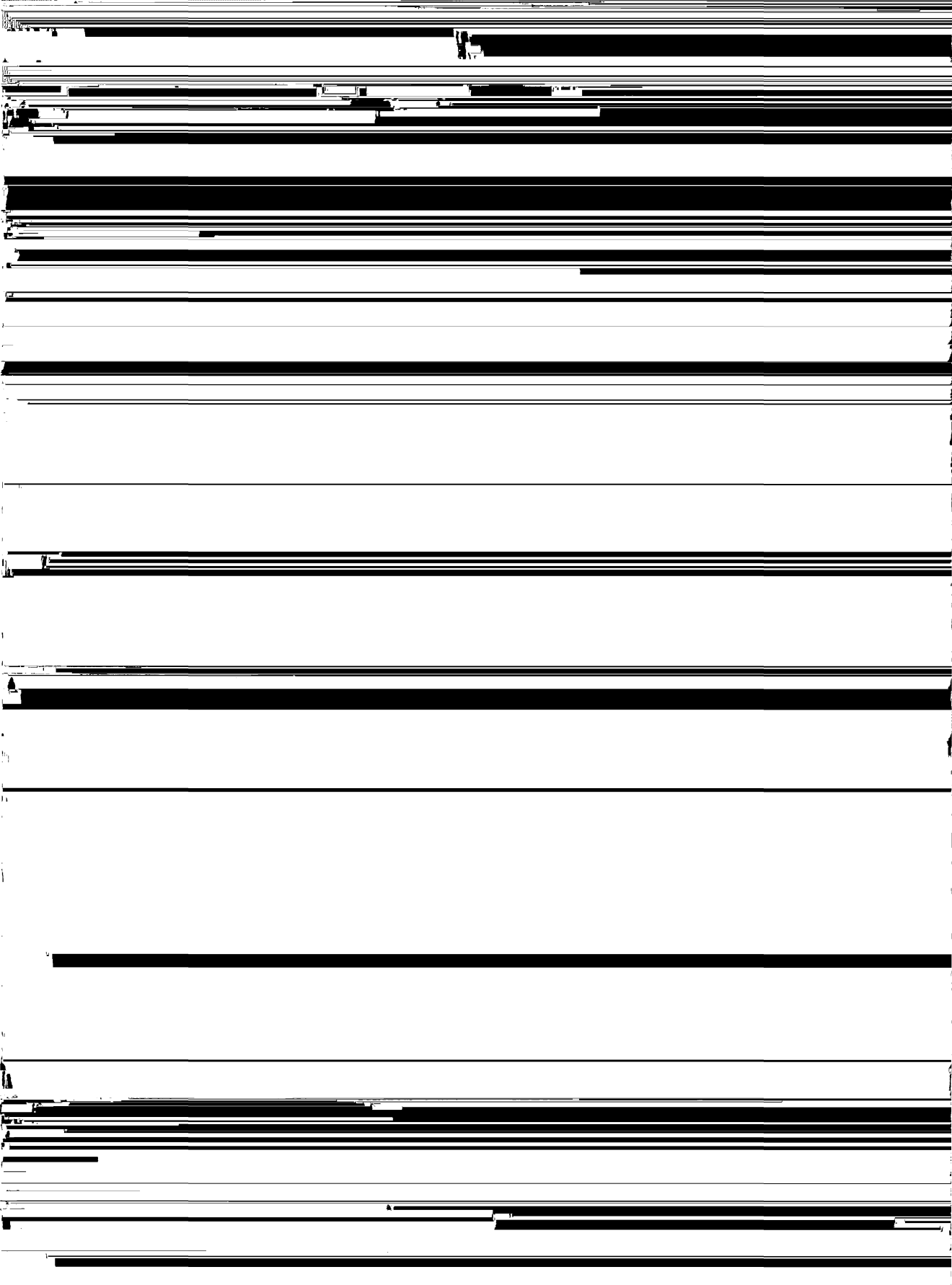




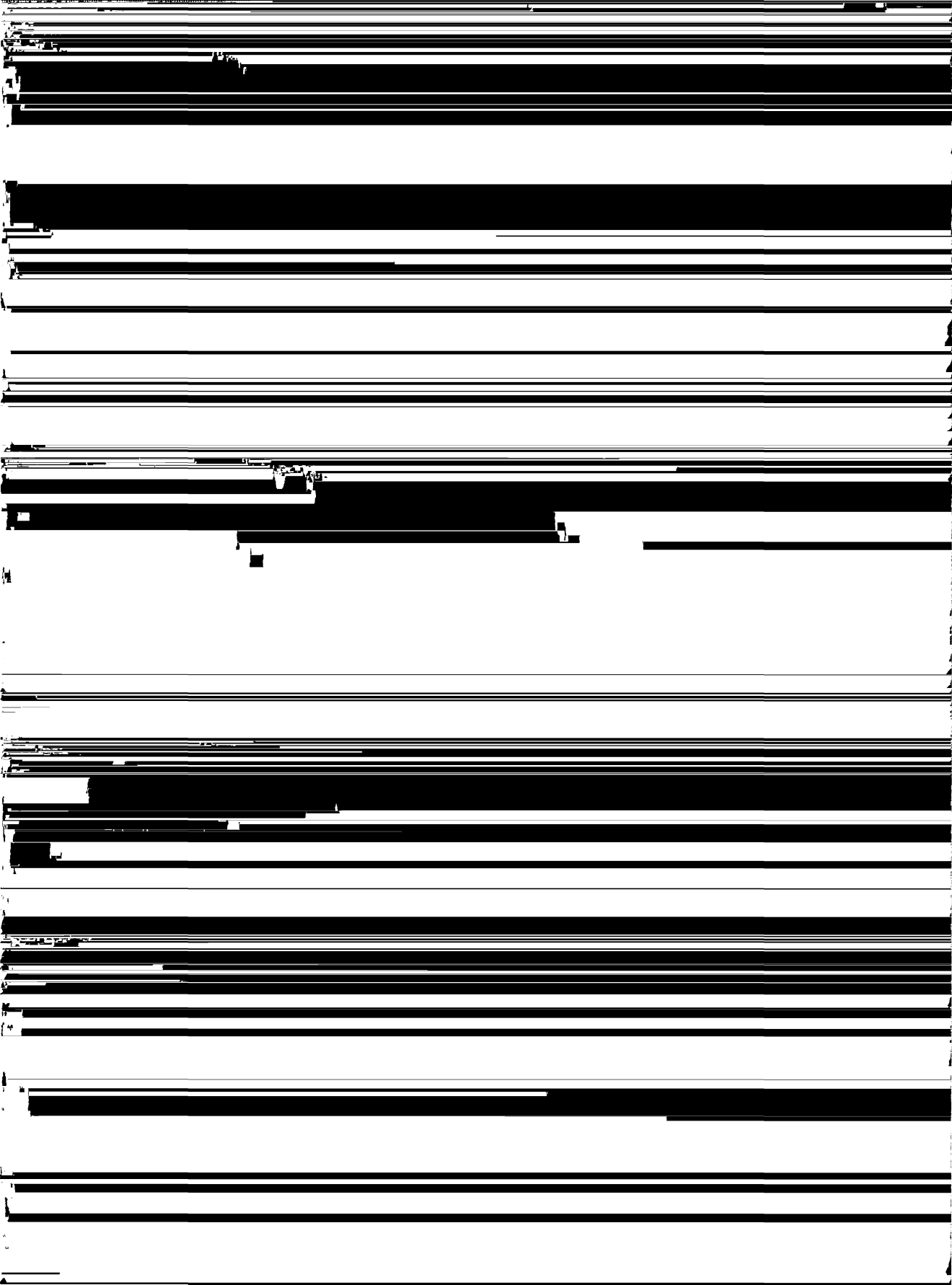


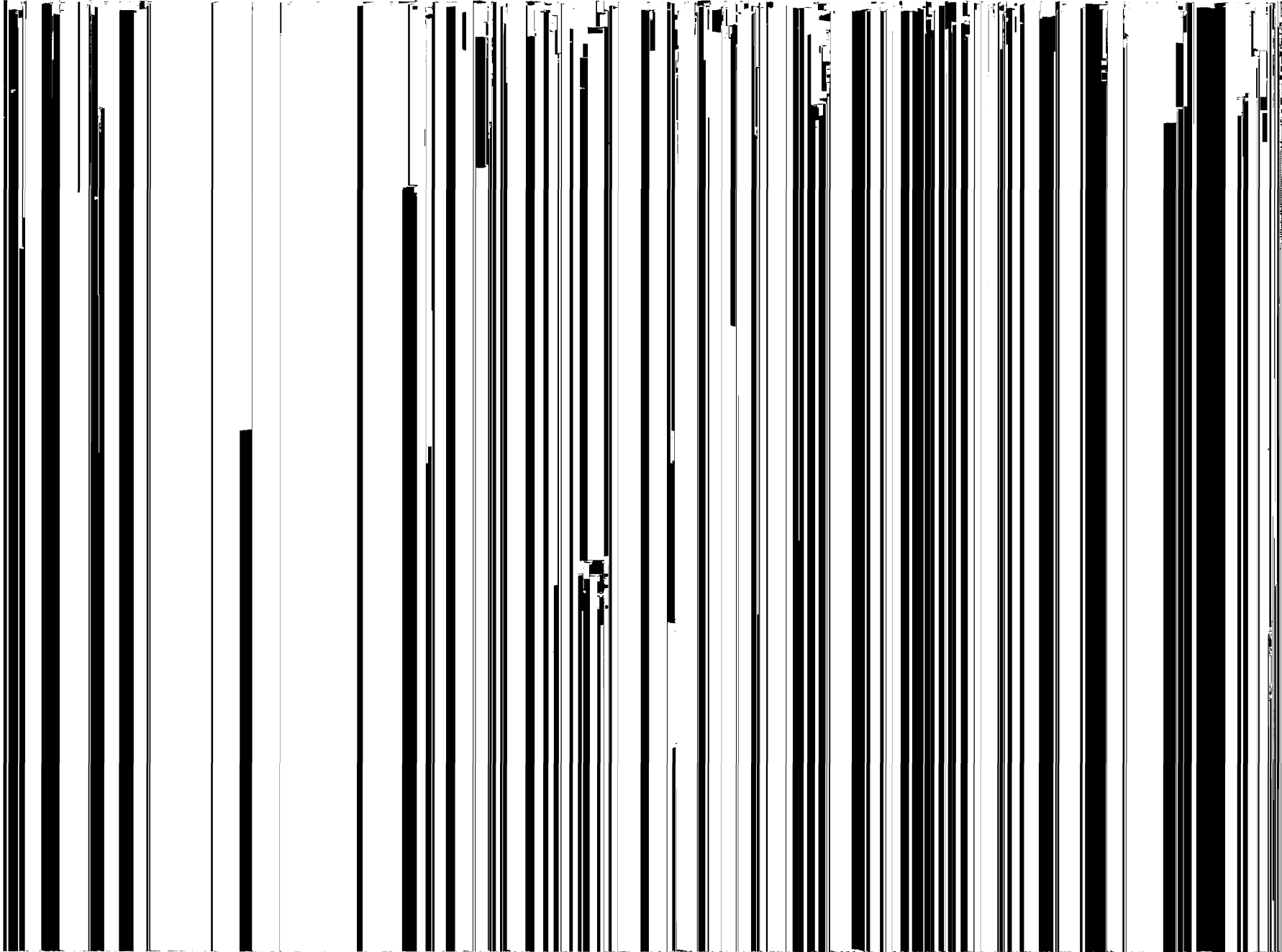


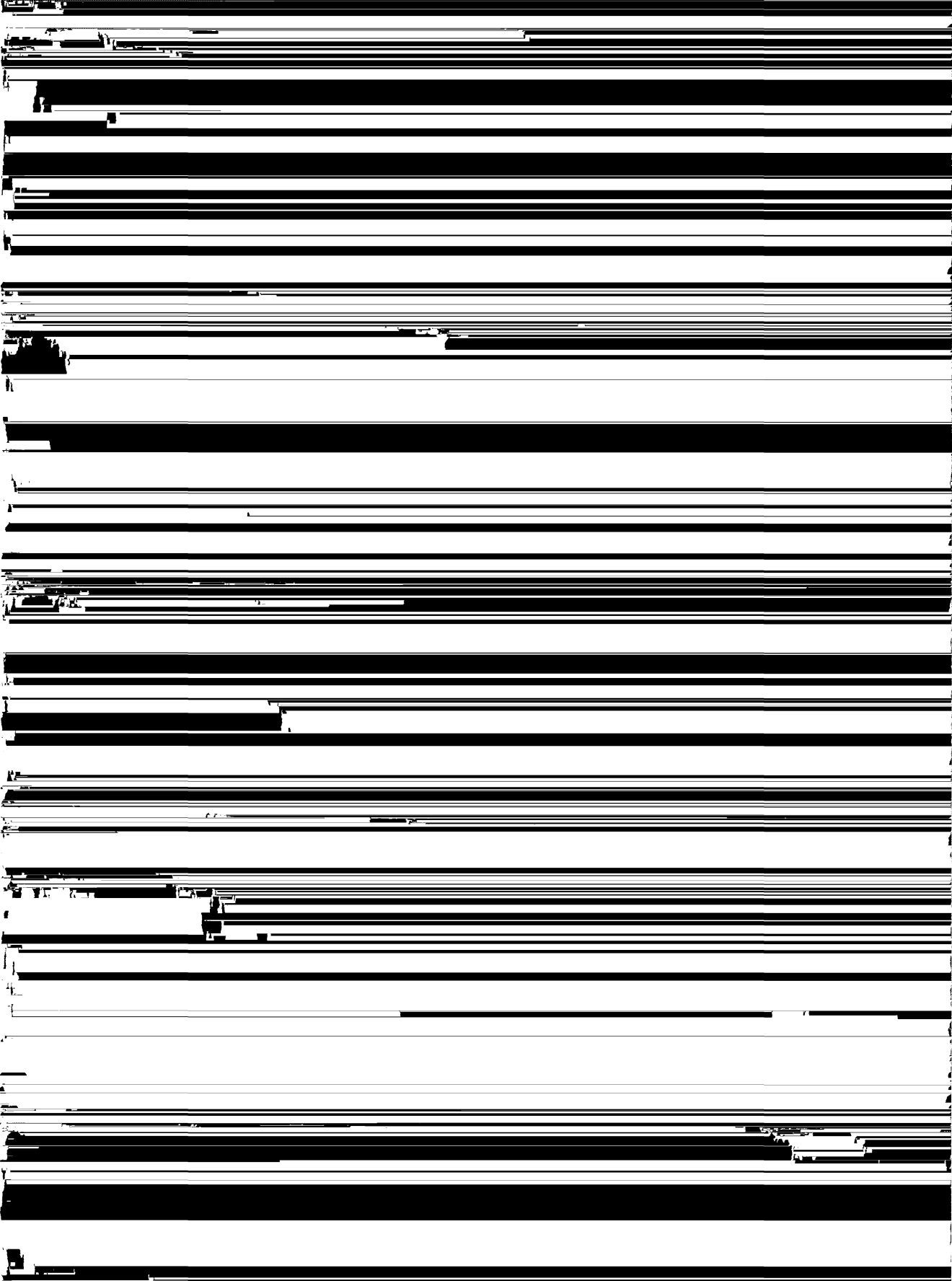


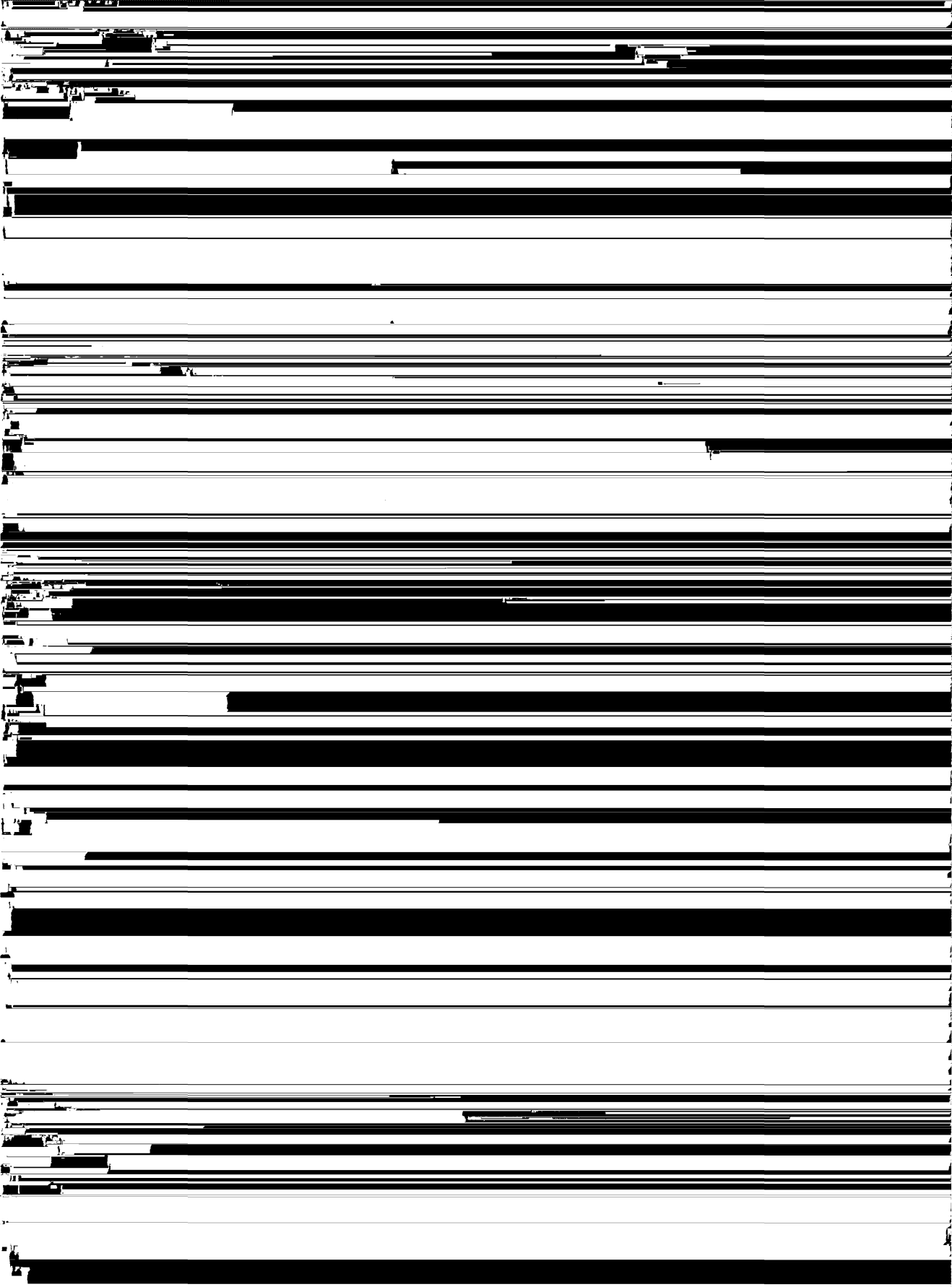


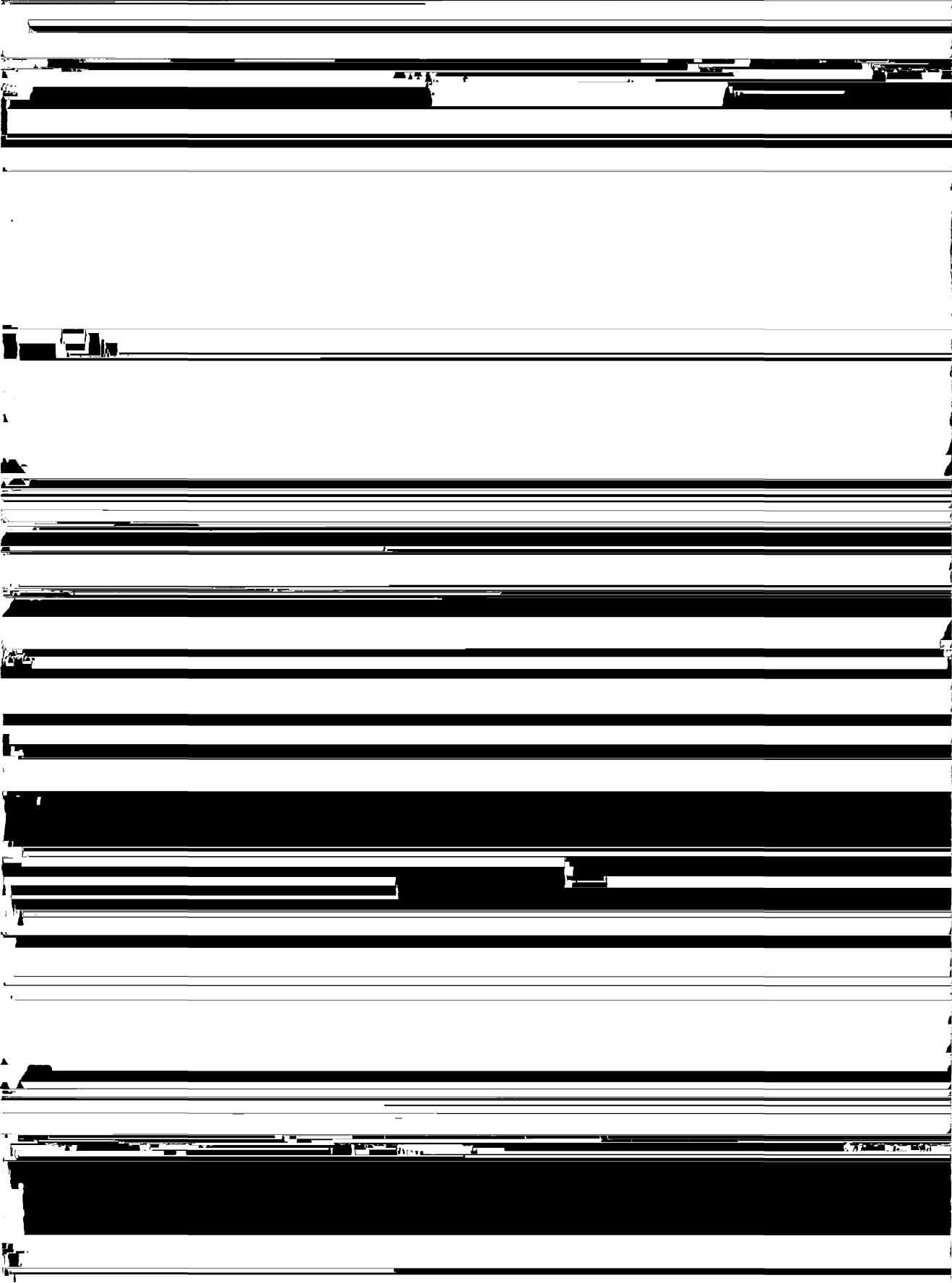


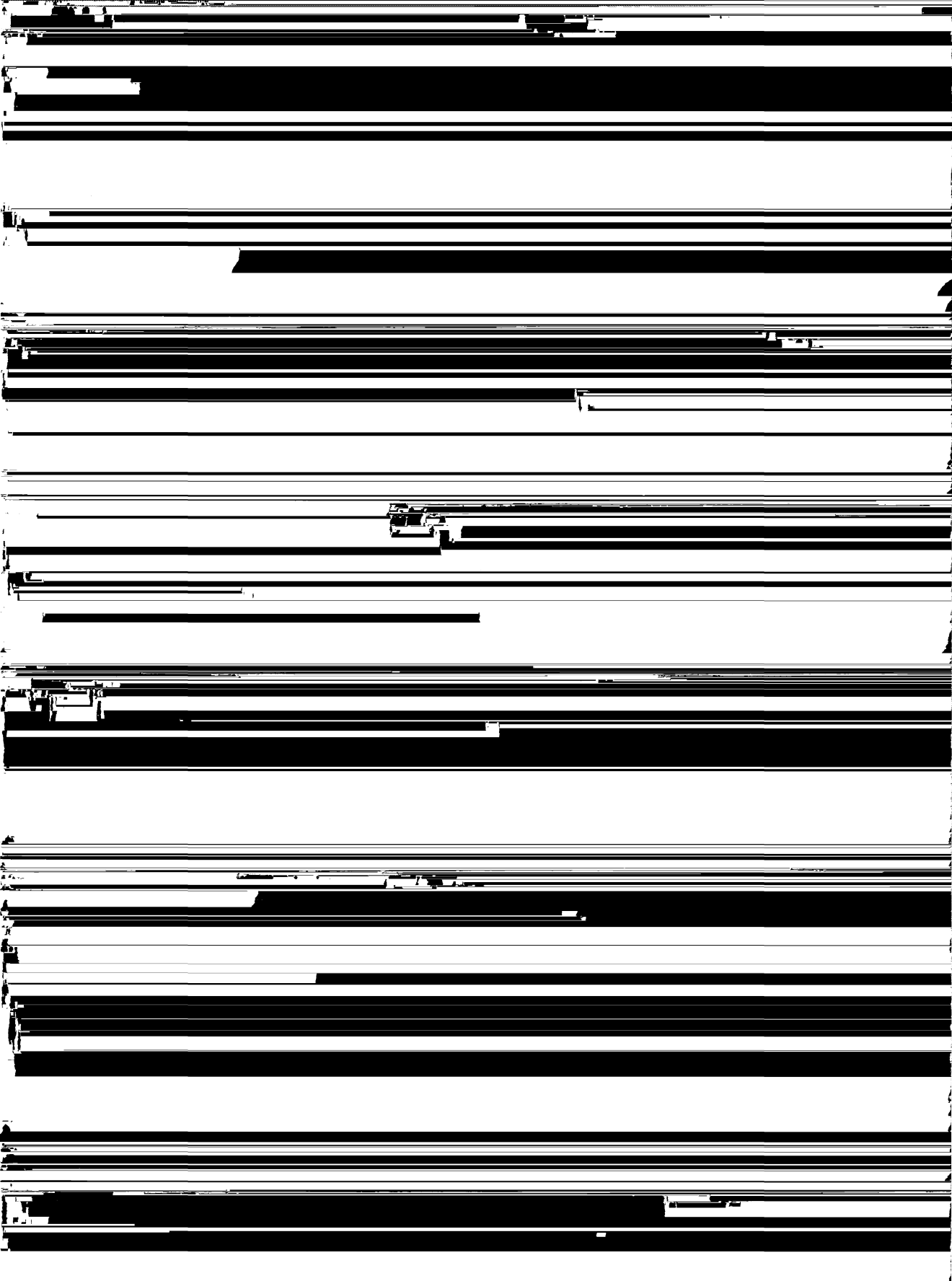


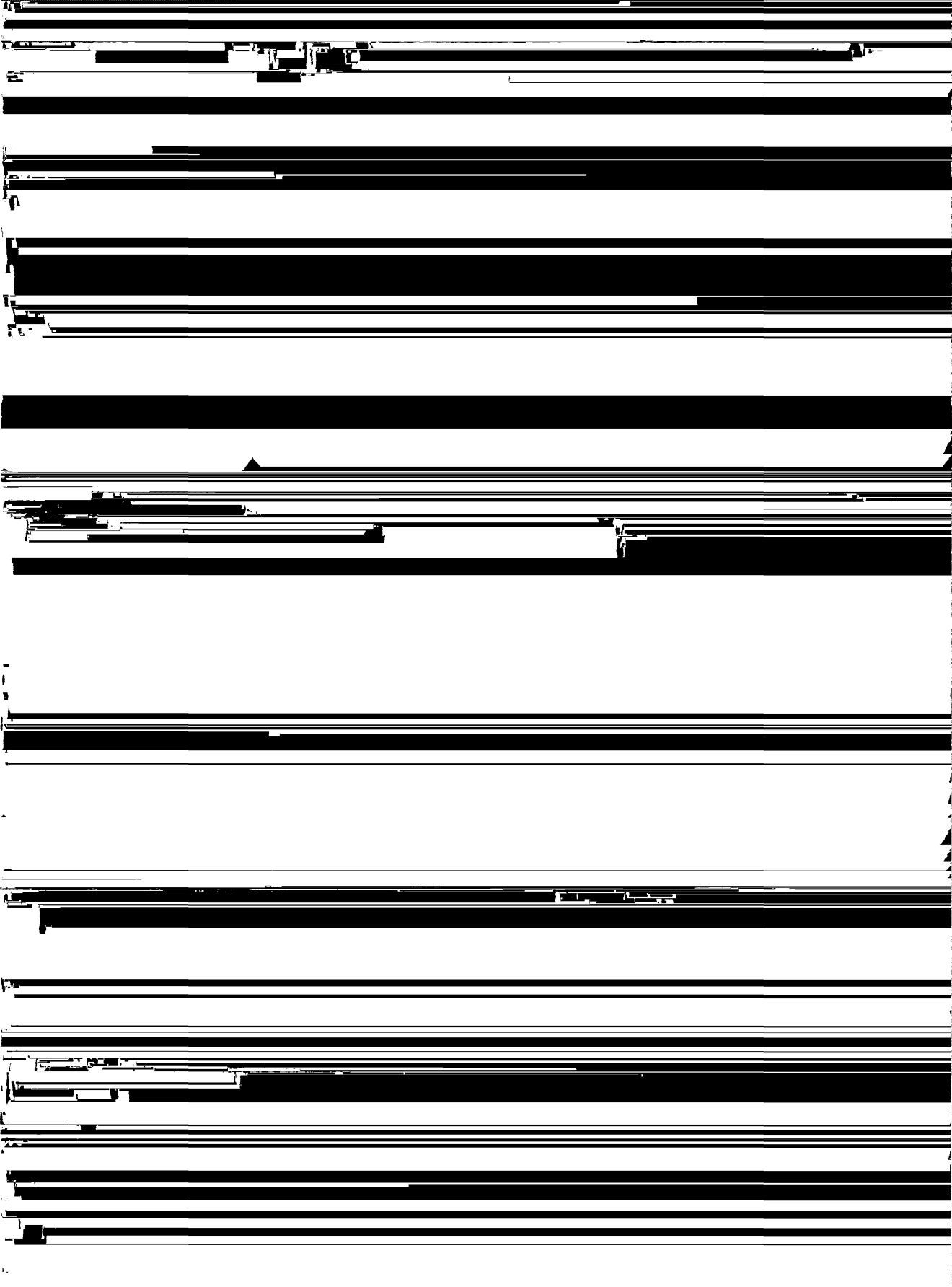


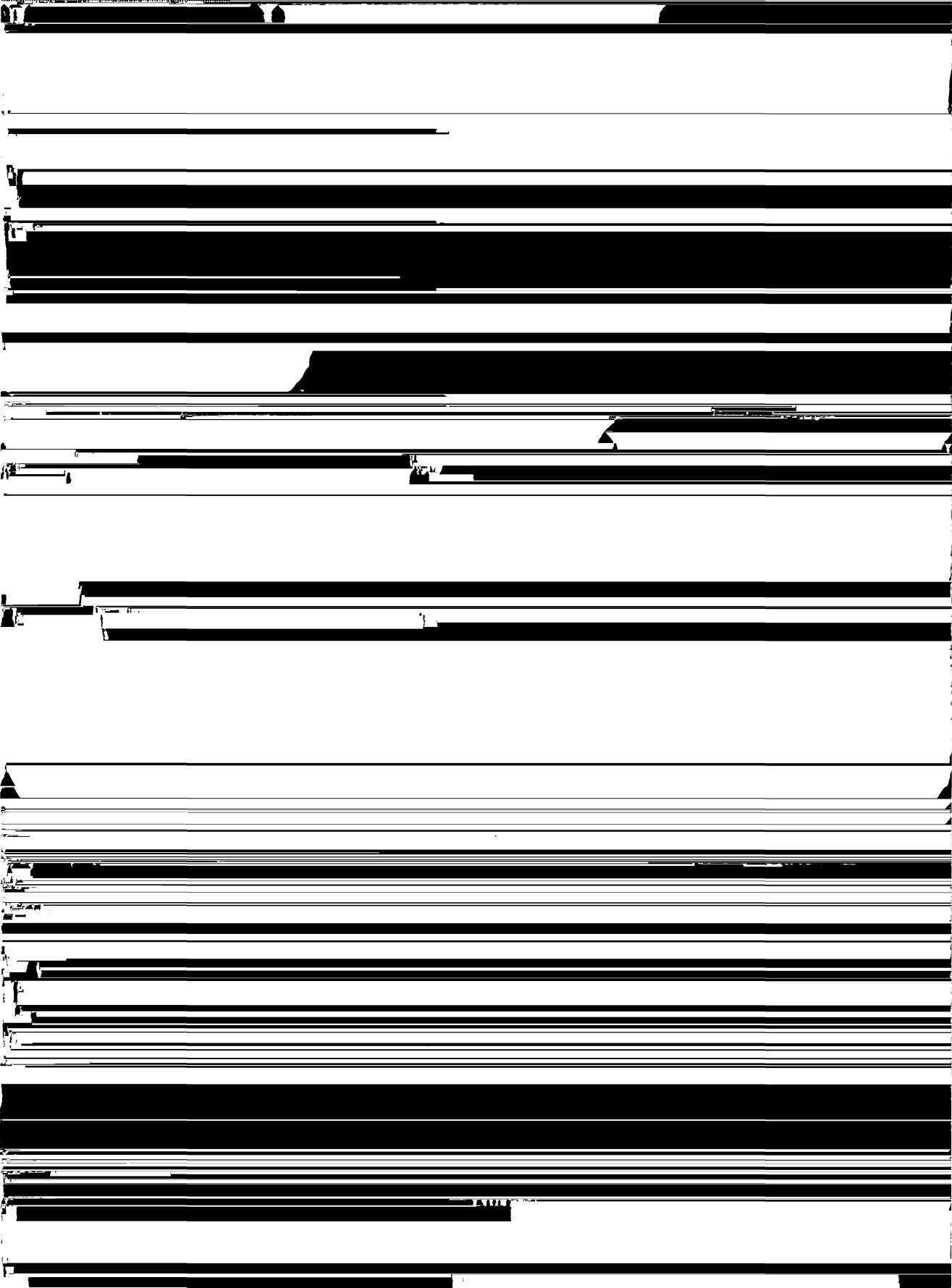


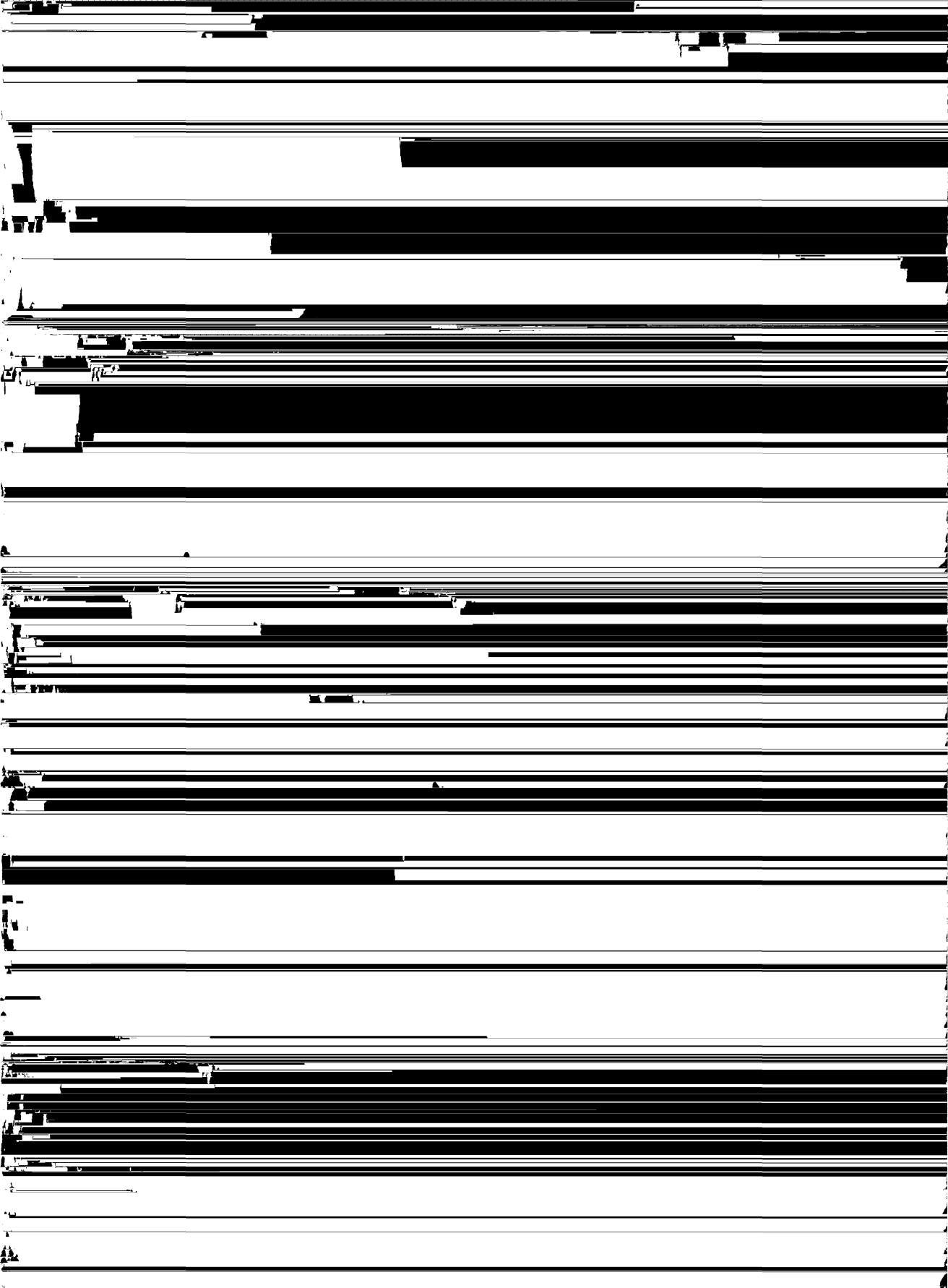


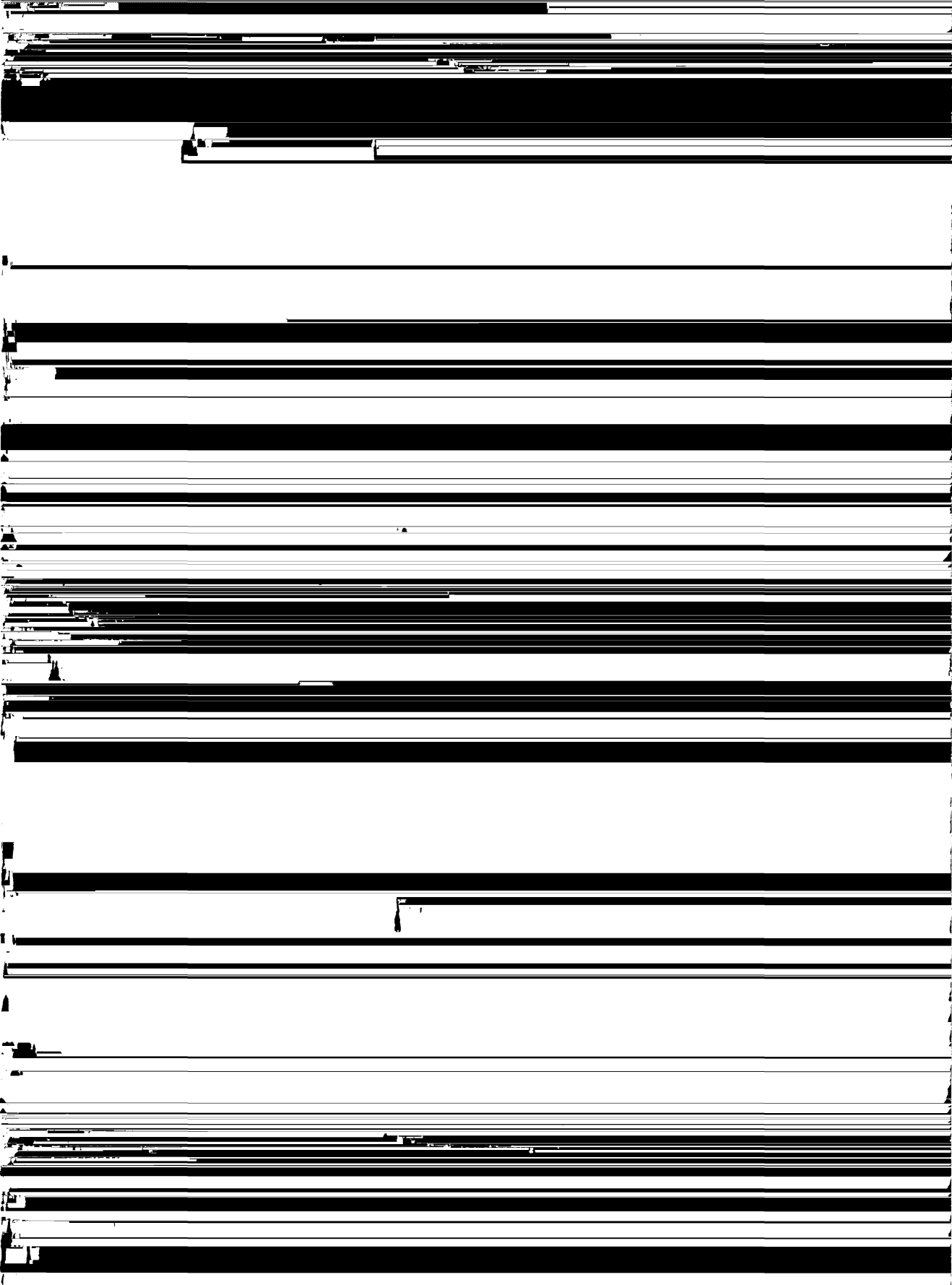


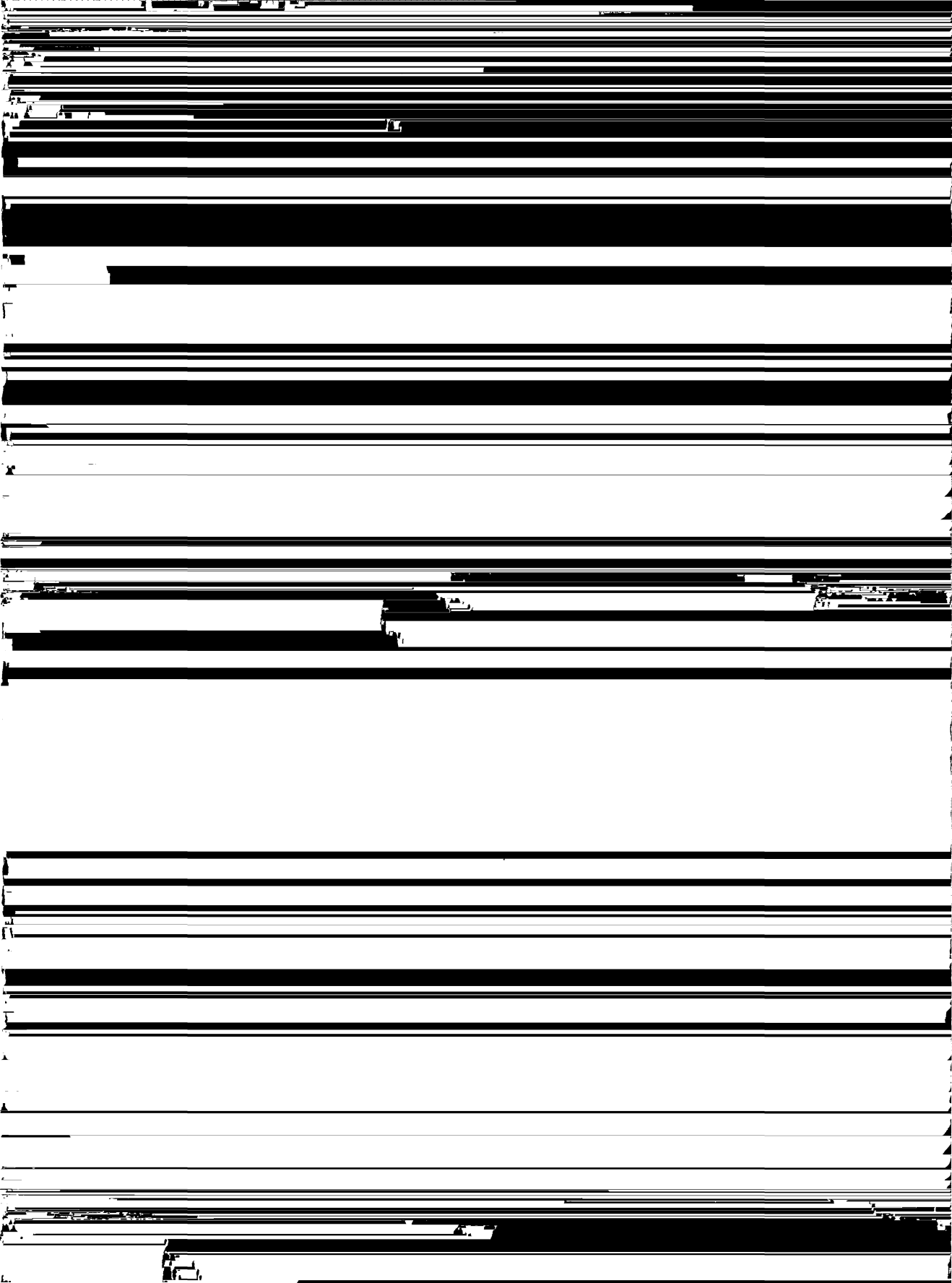




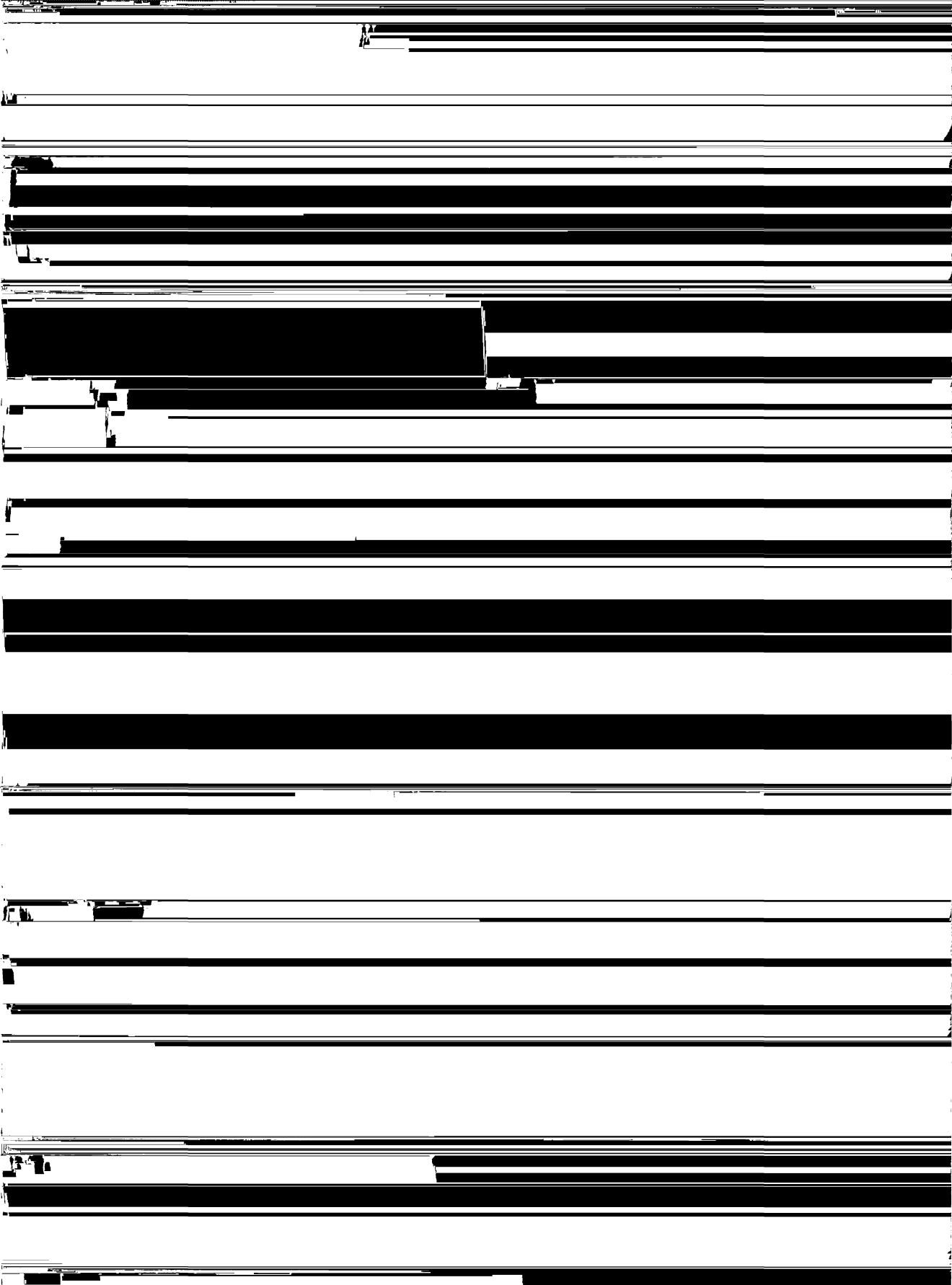


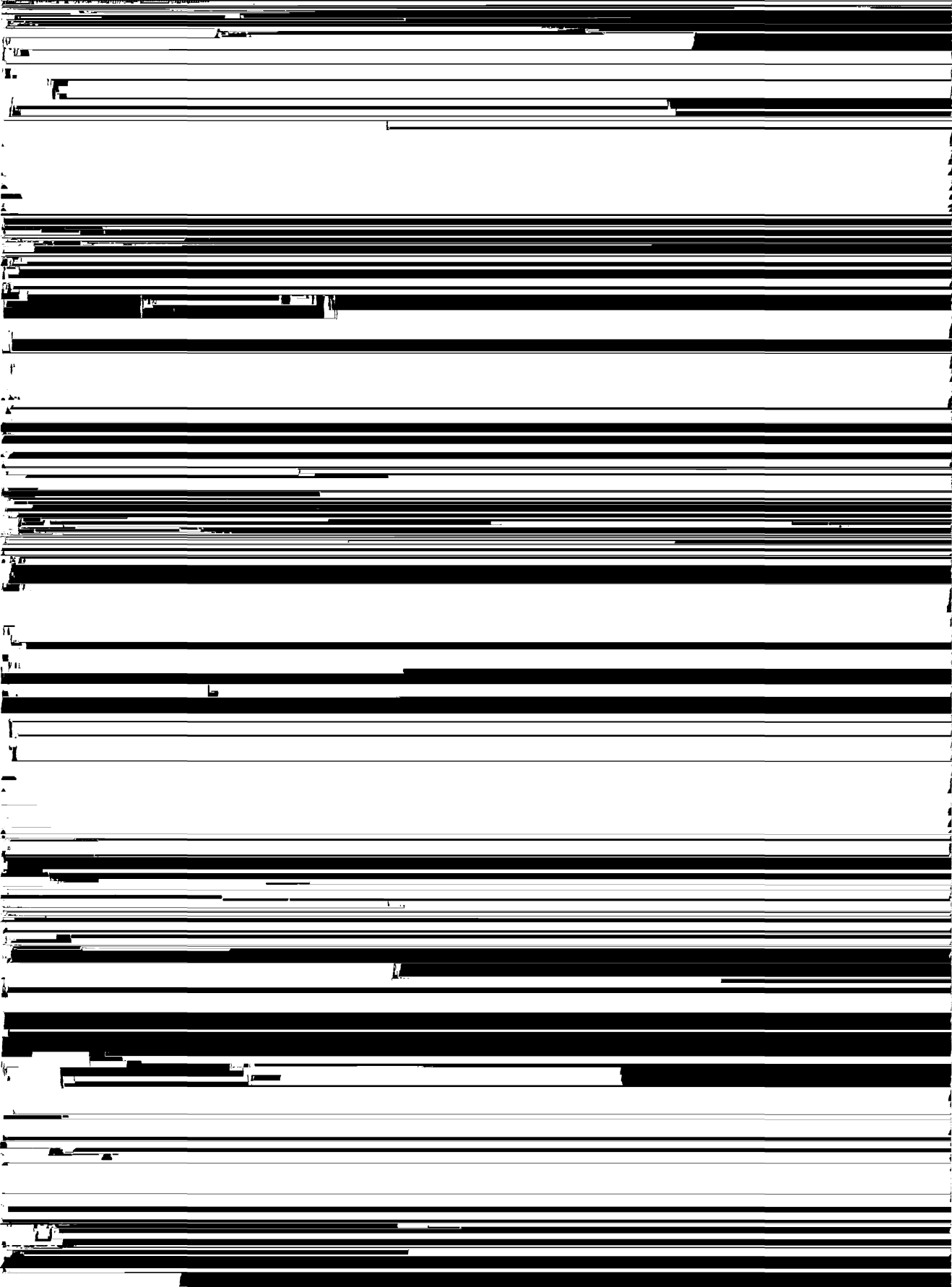


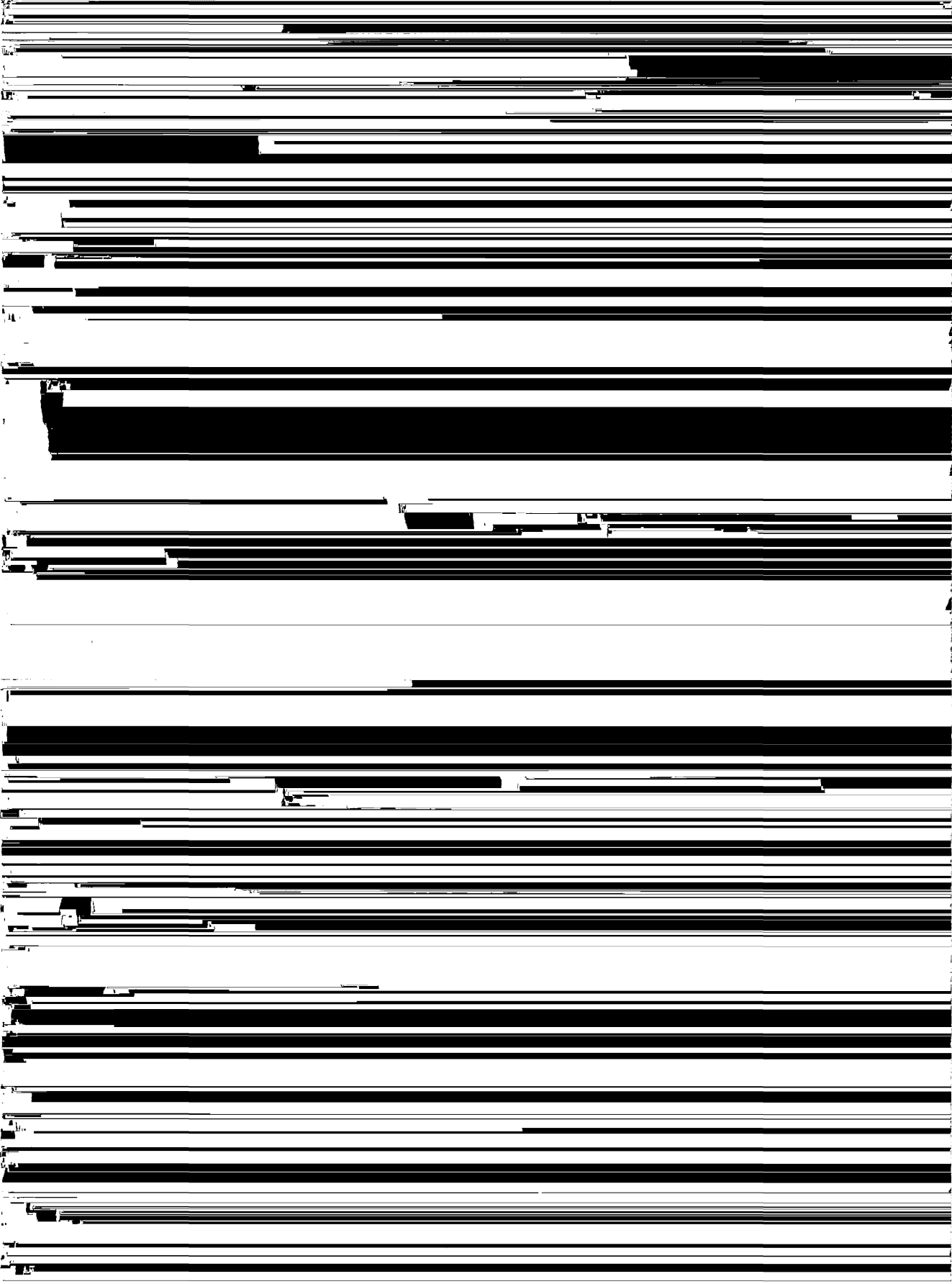


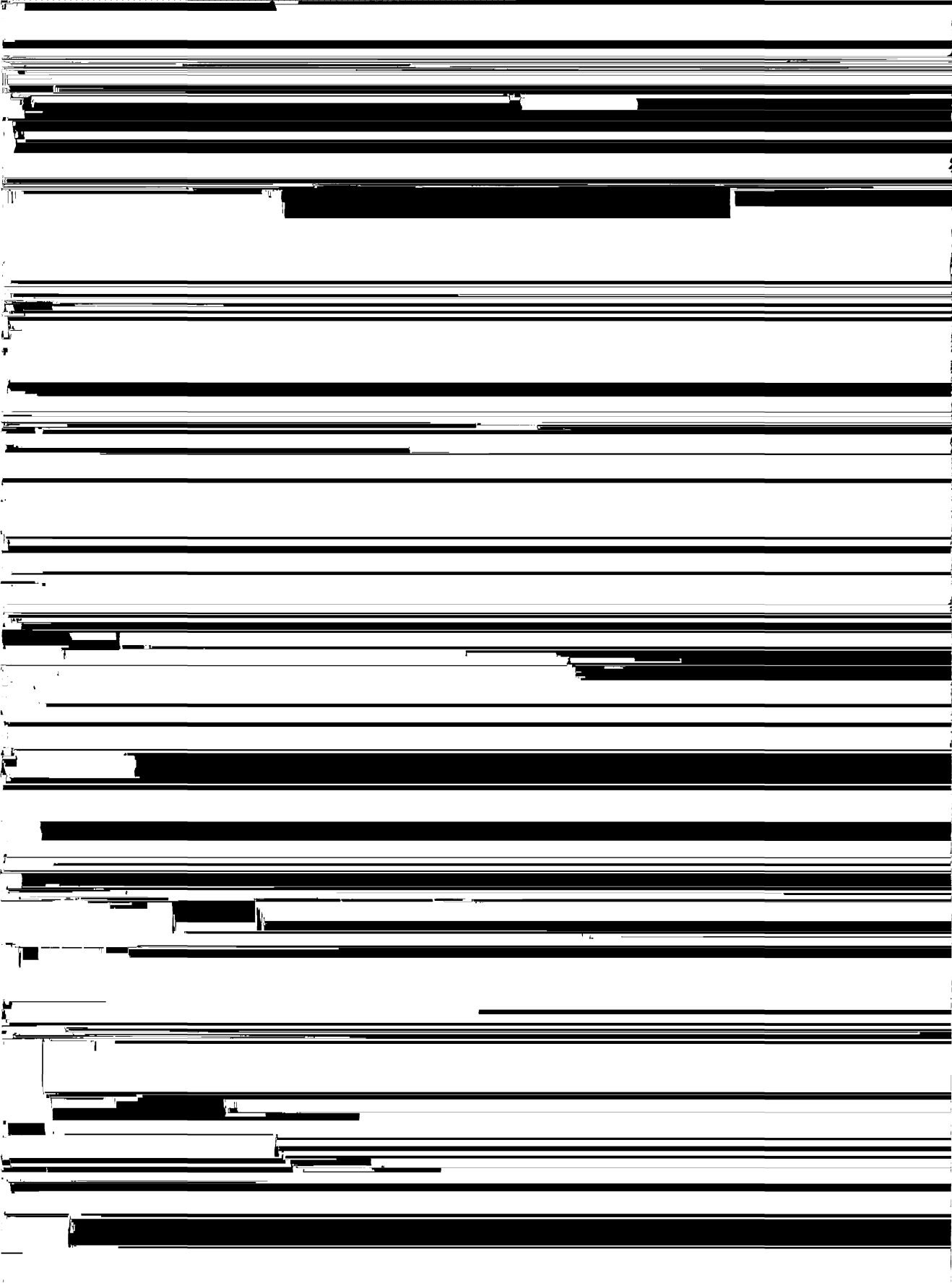


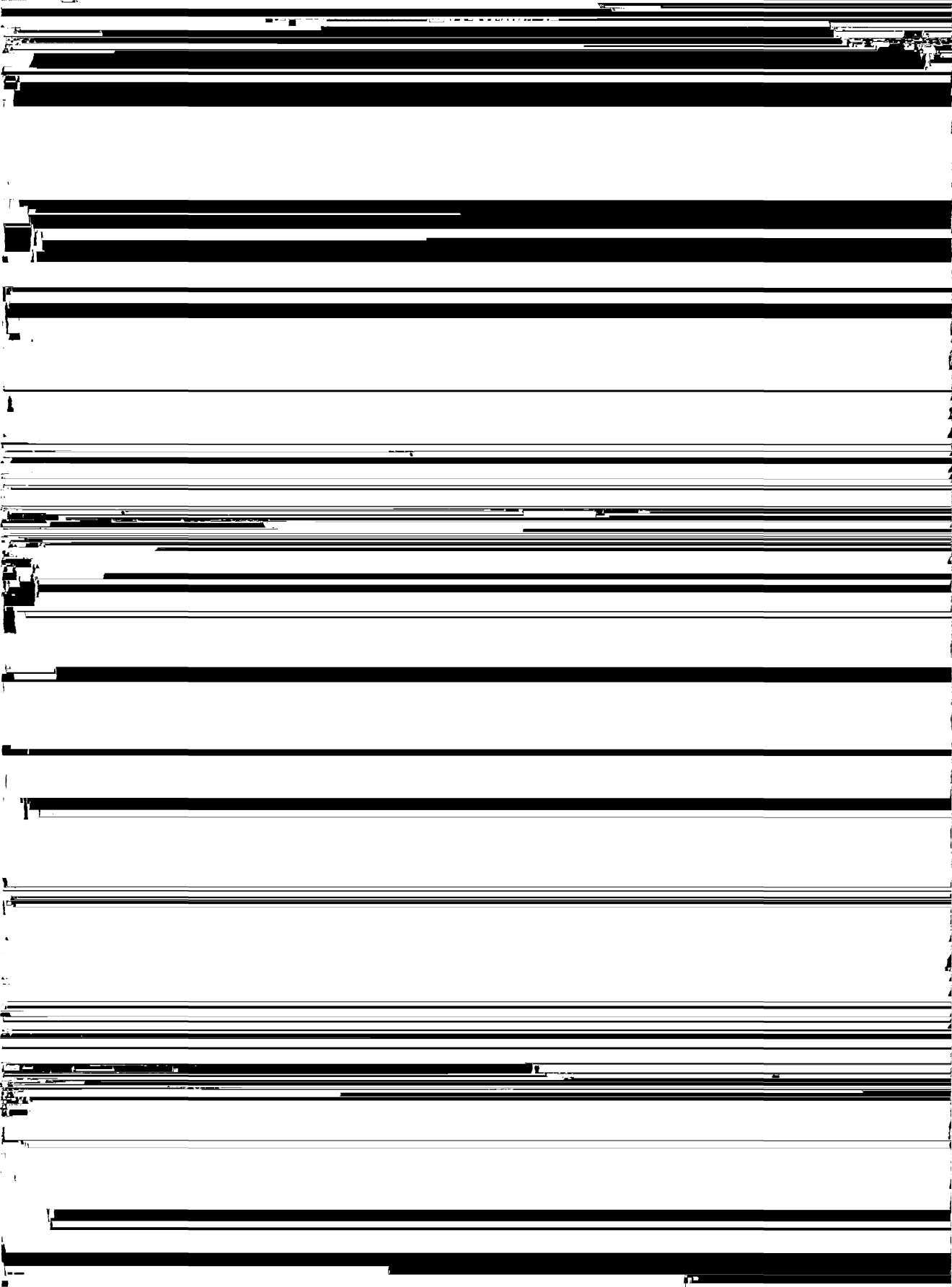






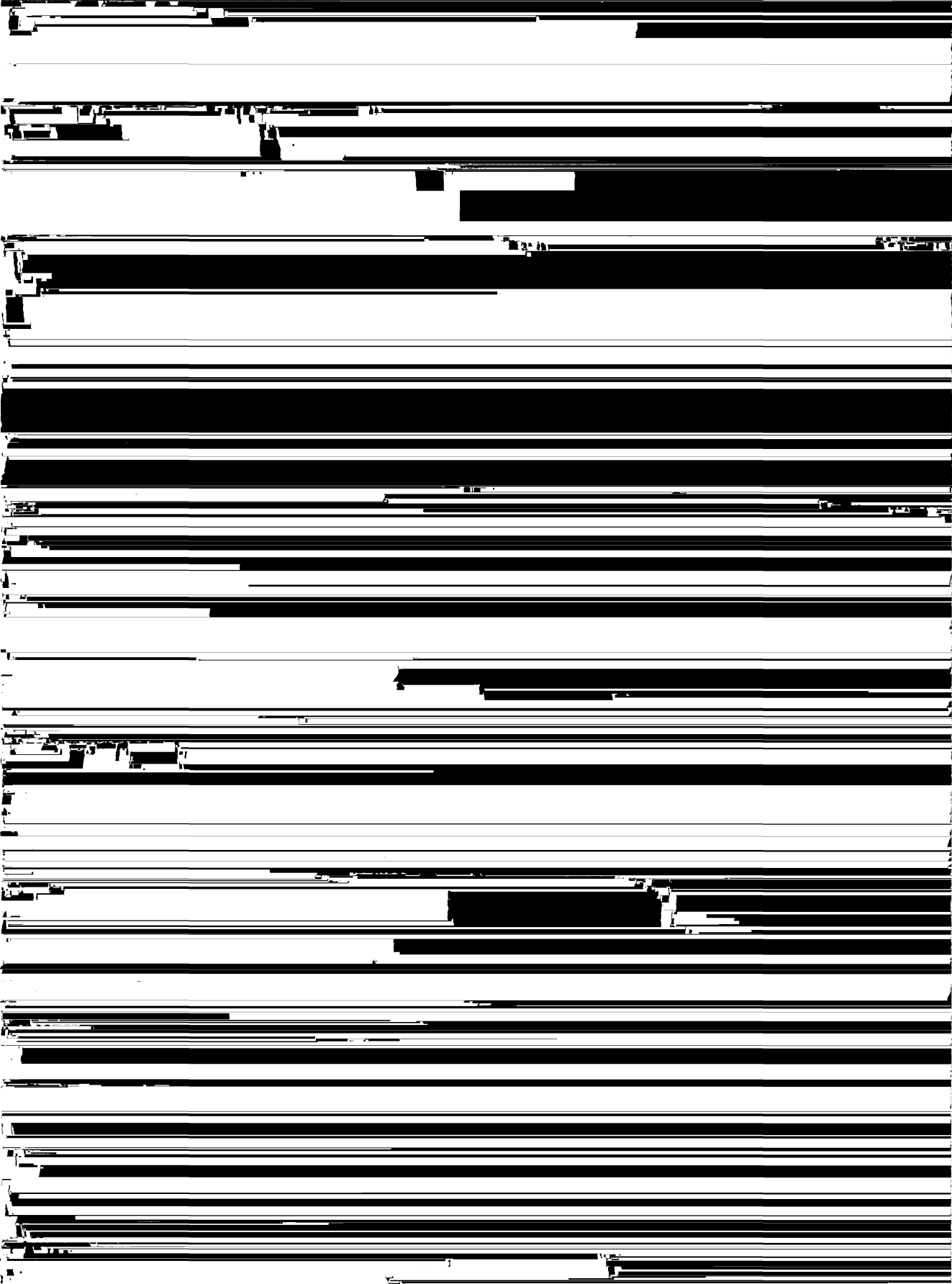


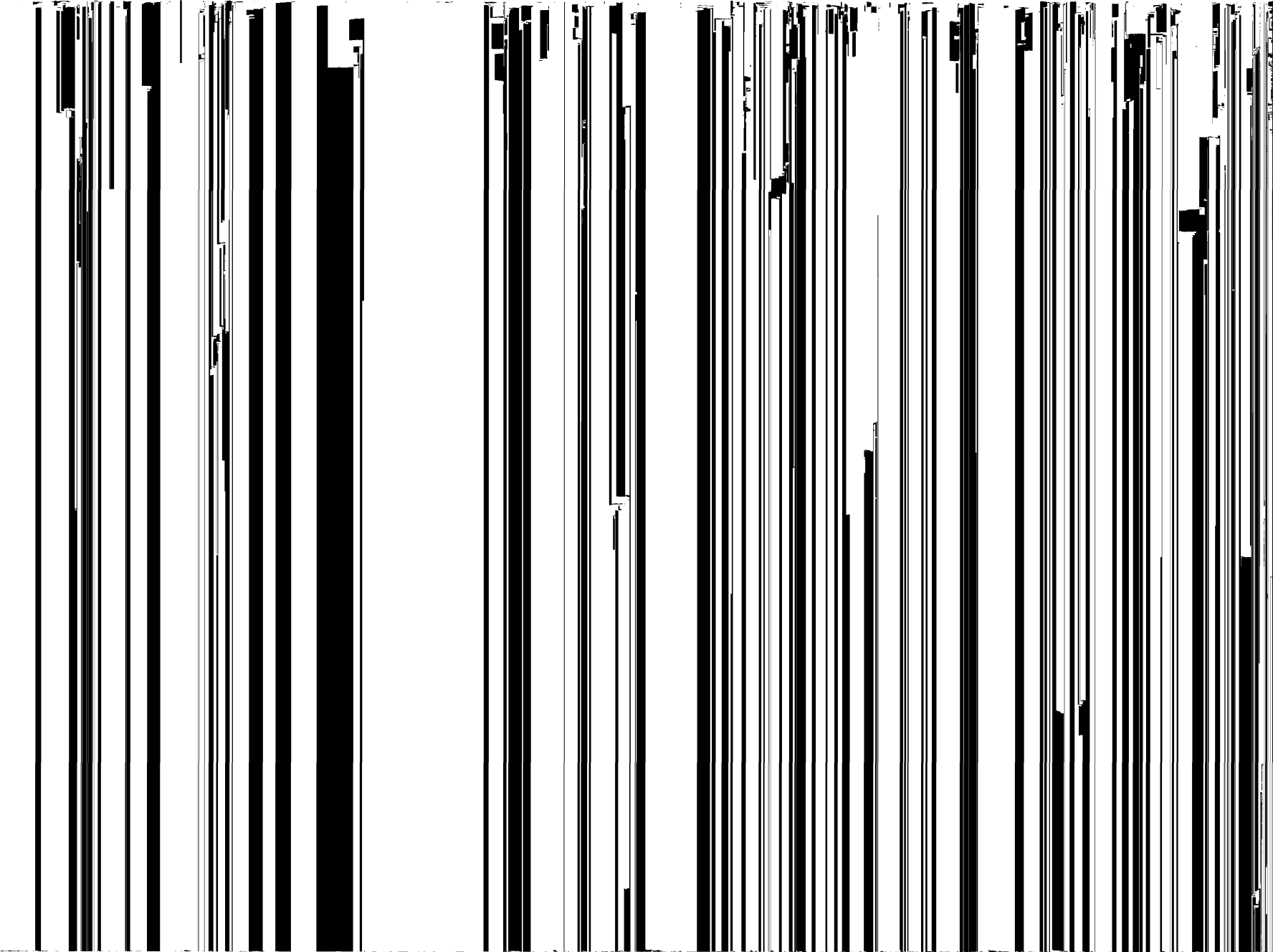


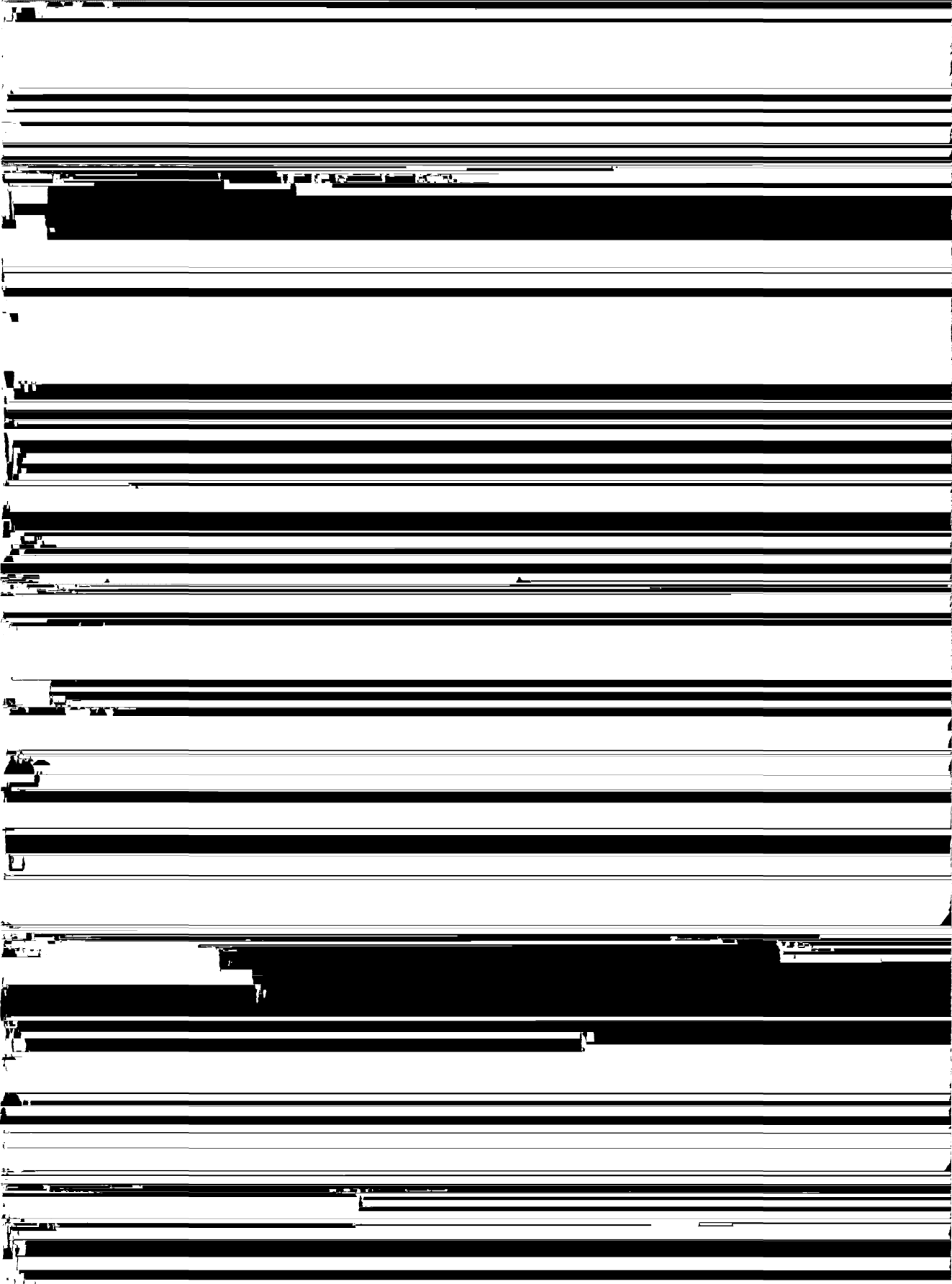


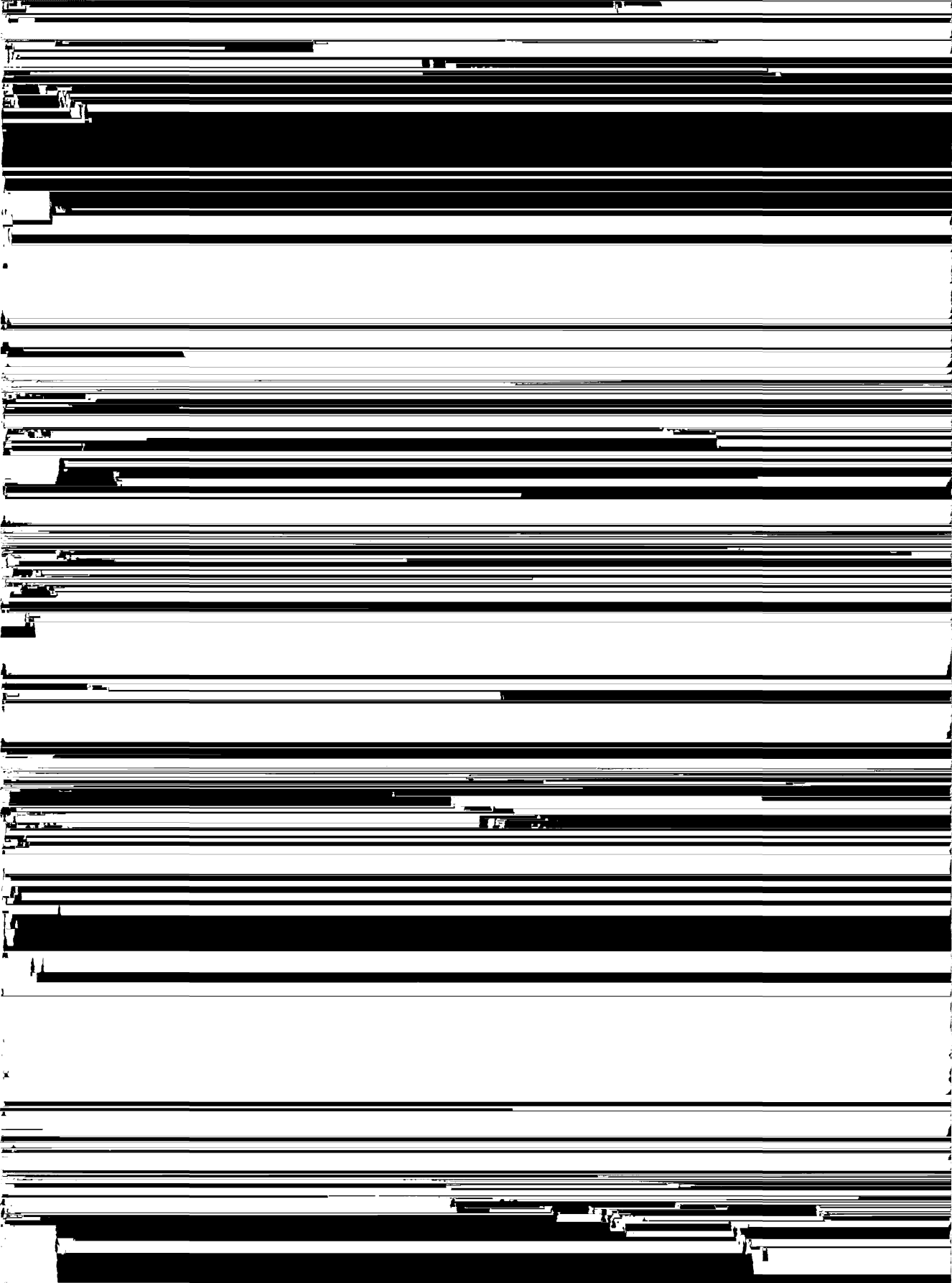


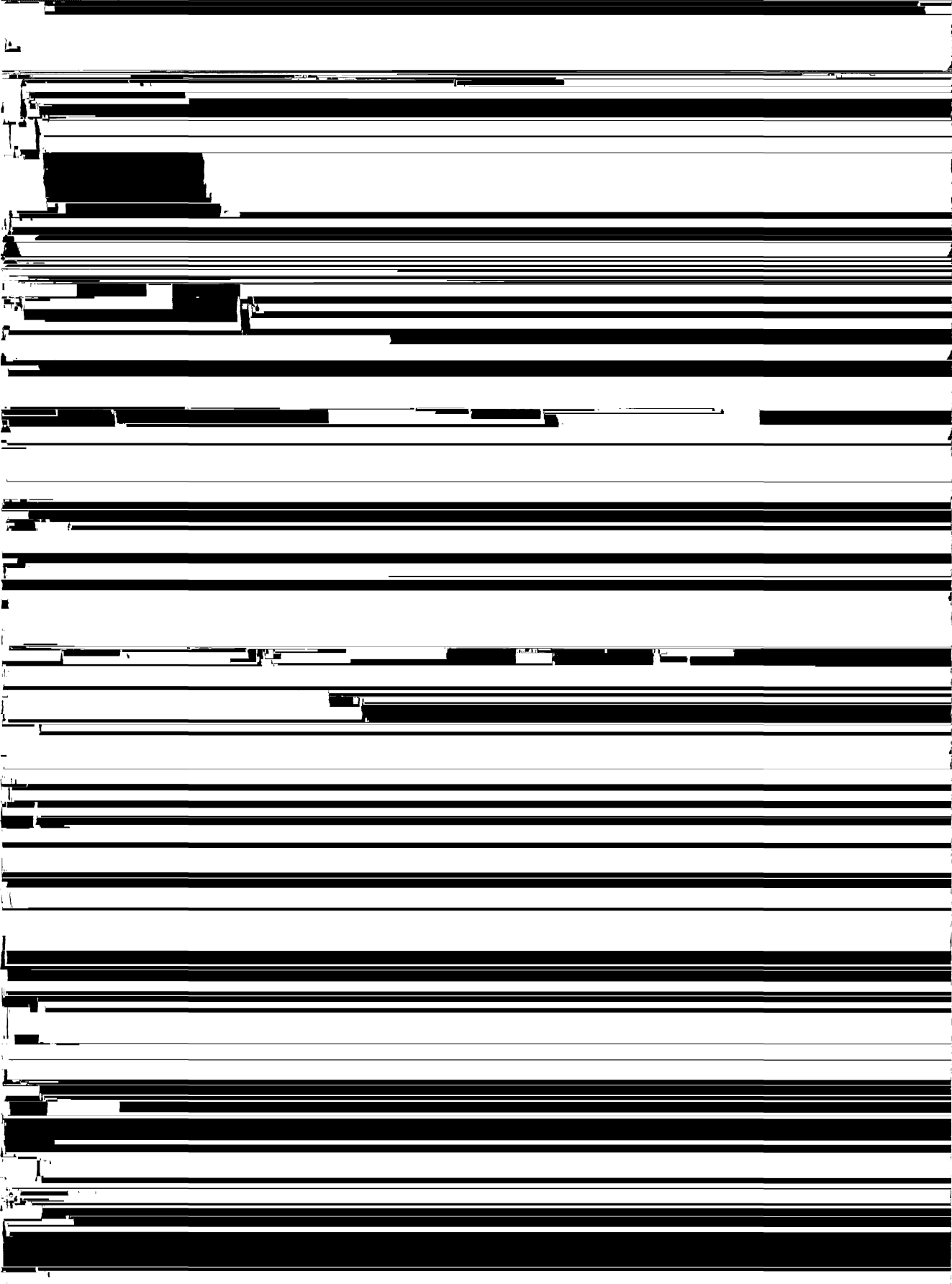


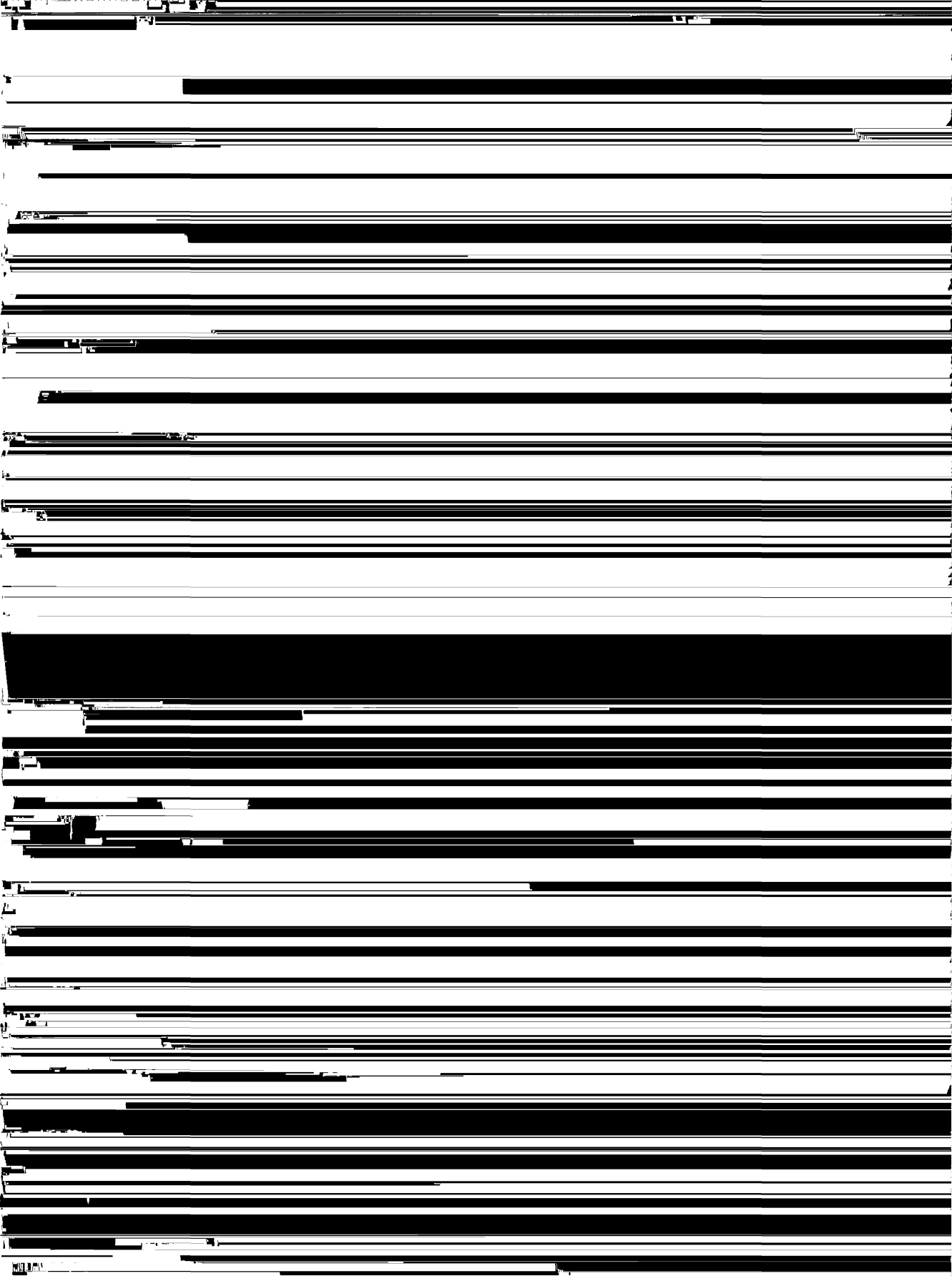


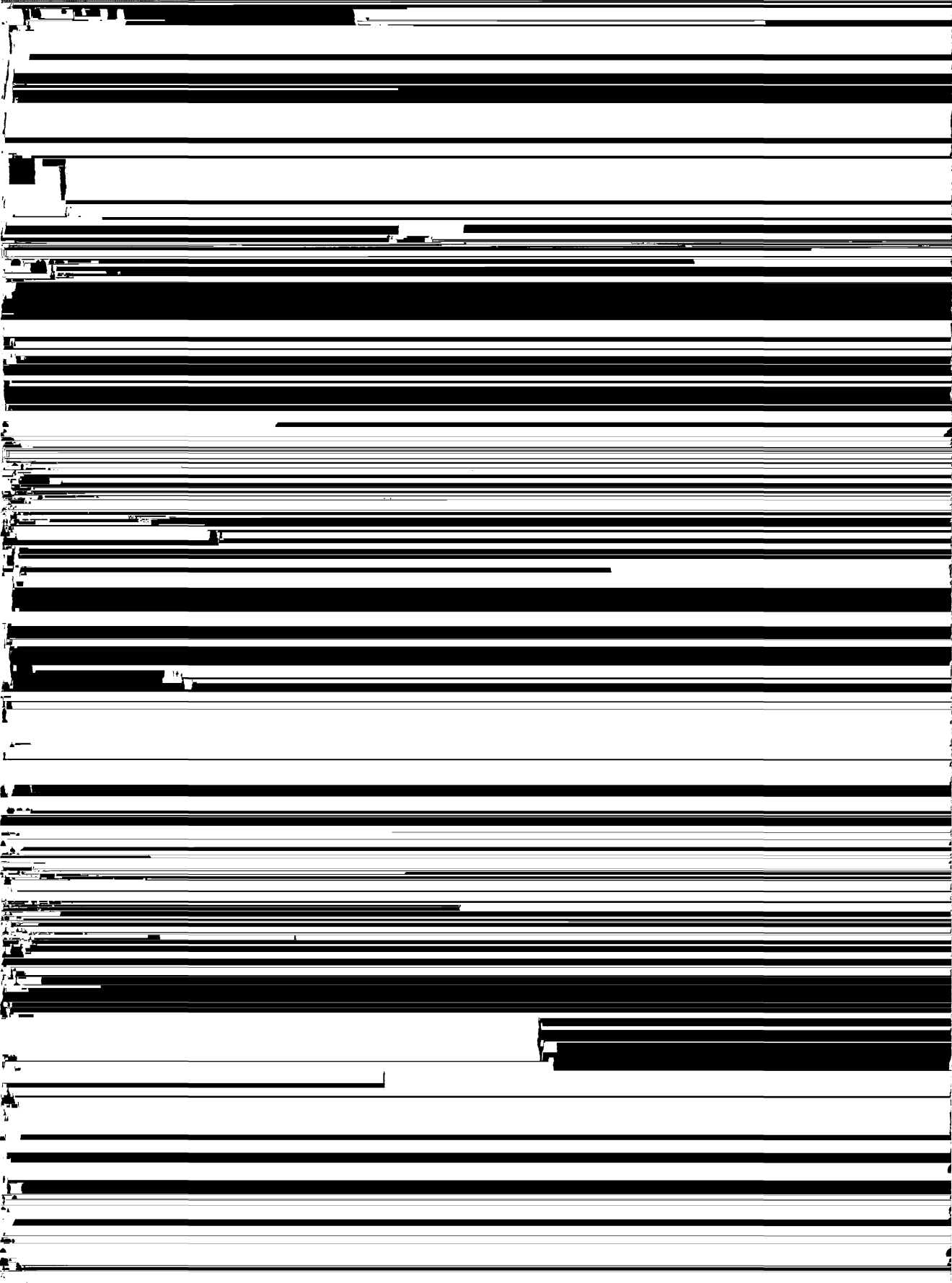


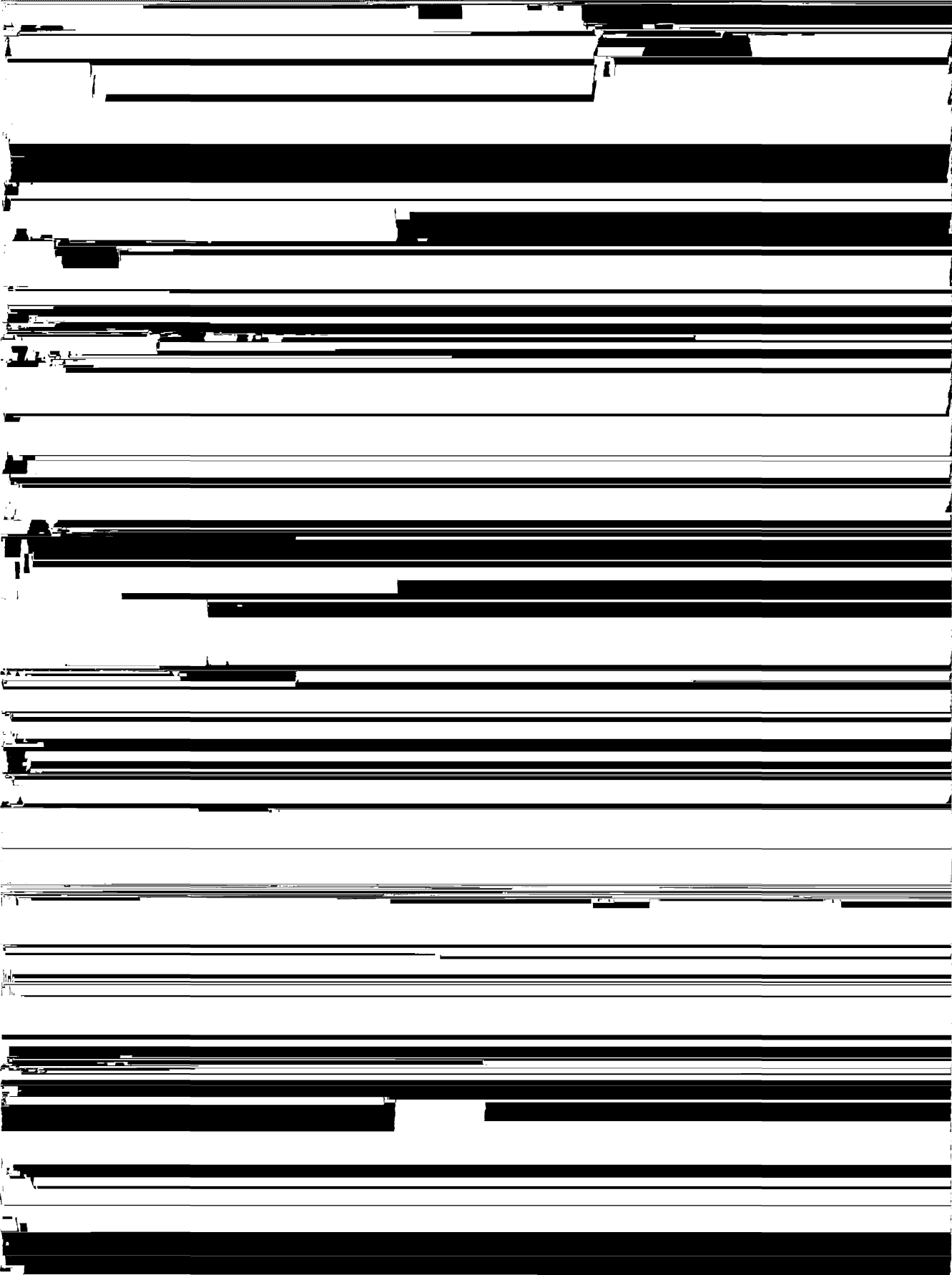


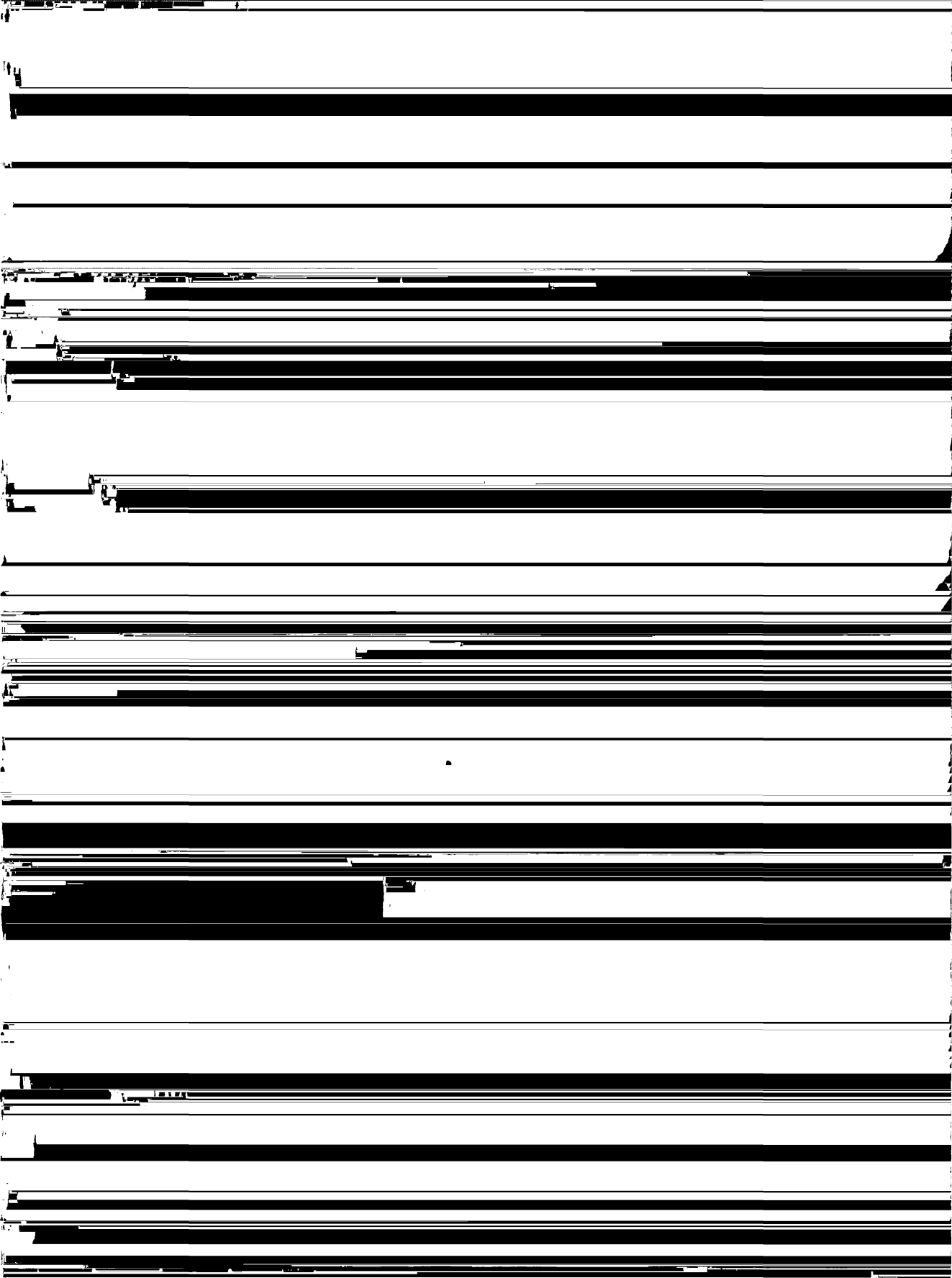












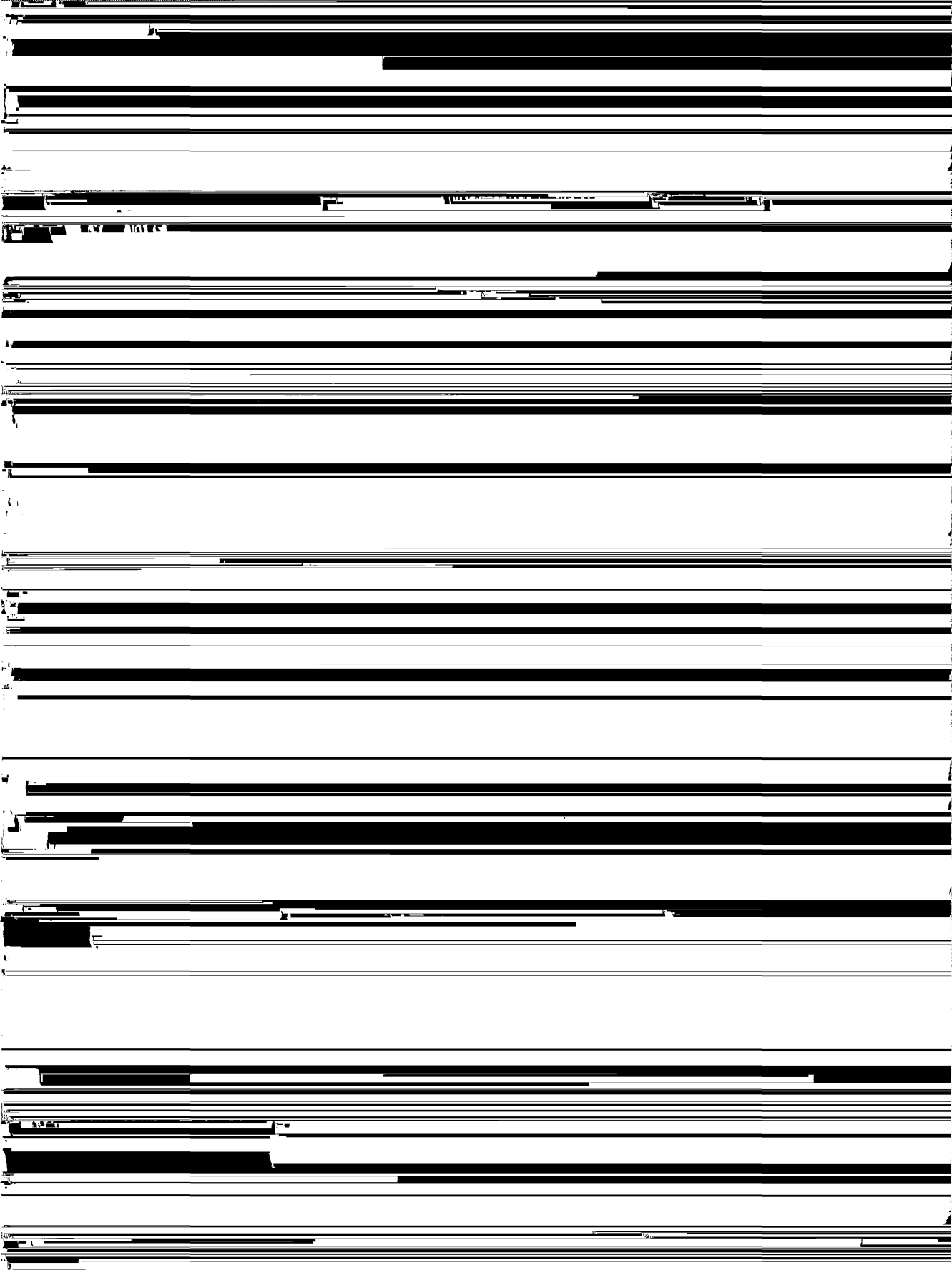
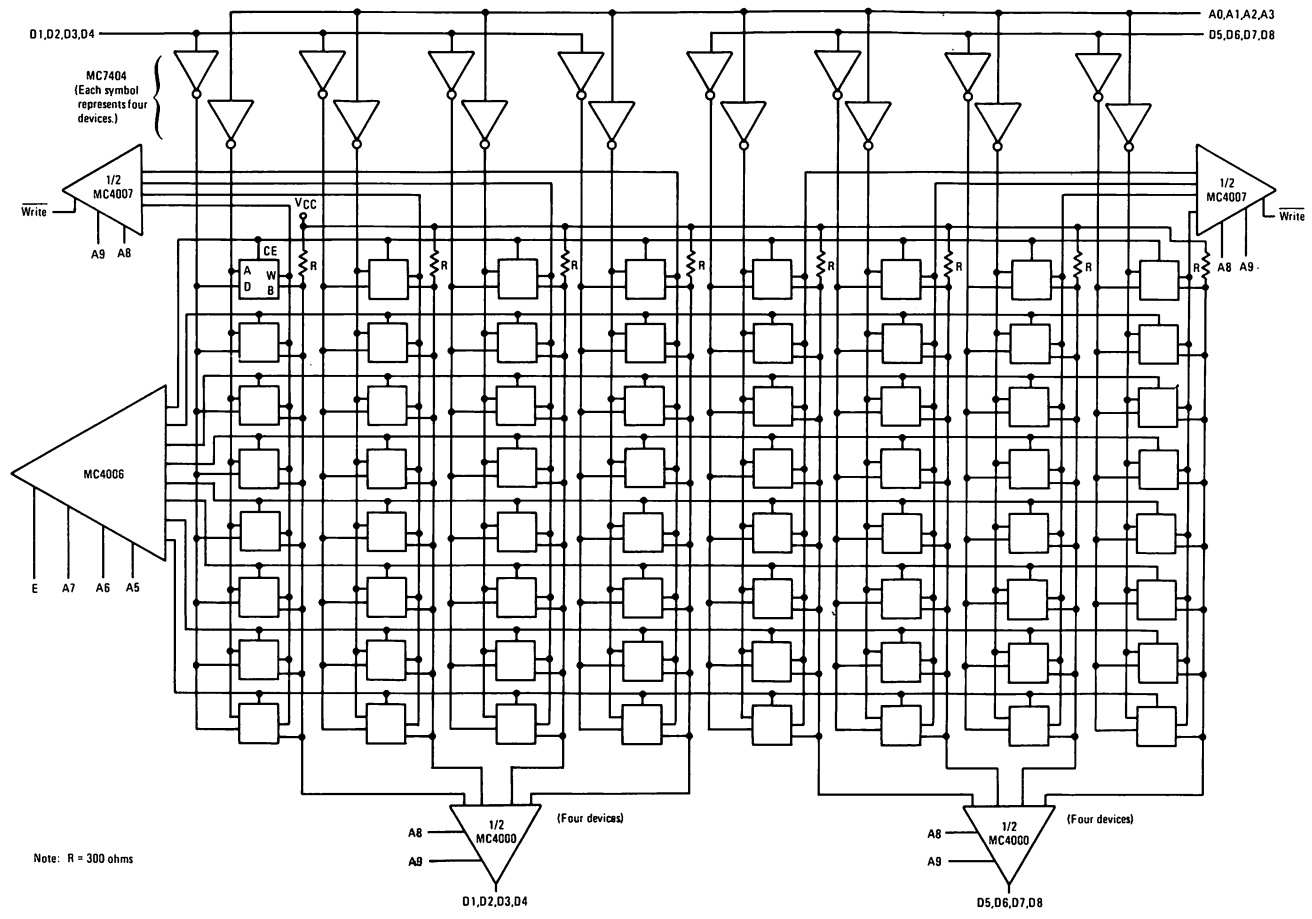






FIGURE 7 - 512-WORD BY 8-BIT READ/WRITE MEMORY SYSTEM



MOTOROLA Semiconductor Products Inc.
 BOX 20912 • PHOENIX, ARIZONA 85036 • A SUBSIDIARY OF MOTOROLA INC.

